

From Knowledge to Wisdom

JEP E

ISSN 1934-8975 (Print)

ISSN 1934-8983 (Online)

DOI:10.17265/1934-8975

Journal of Energy and Power Engineering

Volume 10, Number 6, June 2016

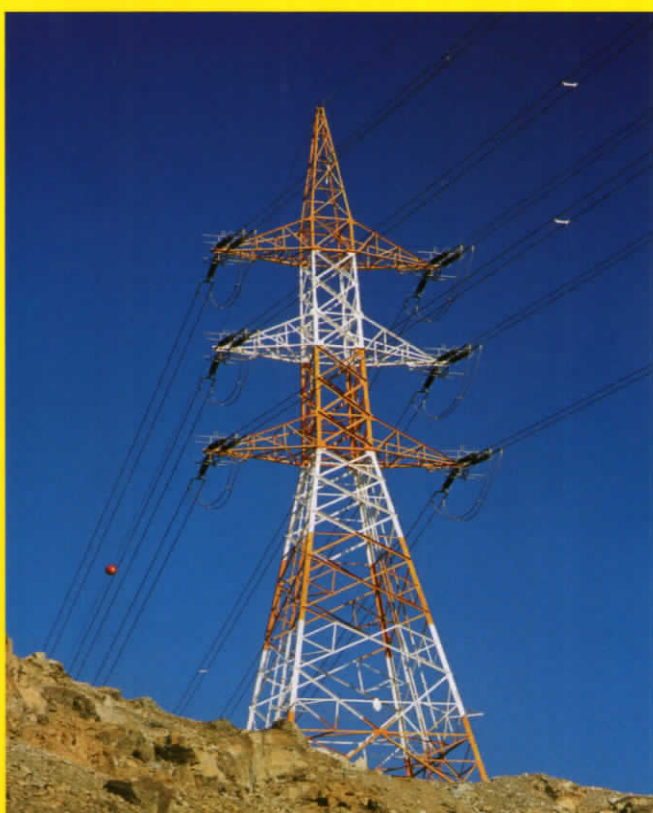

David Publishing Company
www.davidpublisher.com

Journal of Energy and Power Engineering

Volume 10, Number 6, June 2016 (Serial Number 103)



David Publishing Company
www.davidpublisher.com

Paper Status Tracking >>



- Notice**
- About This Journal
 - Editorial Board Members
 - Reviewers
 - Guidelines
 - Publication Ethics Statement
 - Indexing
 - Submission
 - Subscription



This work is licensed under a Creative Commons Attribution-NonCommercial 4.0 International License >>

- Facebook
- Twitter
- LinkedIn

Journals

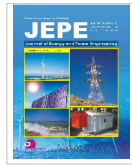

Journal of Energy and Power Engineering

ISSN: 1934-8975 (print) 1934-8983 (online)

Website: <http://www.davidpublisher.com/Home/Journal/JEPE>

Frequency: bimonthly

Volume 16, Number 3, May-June 2022 (Serial Number 163)

Submission

Subscription

About This Journal

Journal of Energy and Power Engineering (print ISSN 1934-8975, and online ISSN 1934-8983) is an international, scholarly and peer-reviewed journal (print and online) published monthly by David Publishing Company, USA which was founded in 2007. The journal aims to publish the most innovative articles from the discipline of Energy and Power.

The Current columns involve thermal science; fluid mechanics; energy and environment; power system and automation; power electronic; high voltage and pulse power; and sustainable energy. We are welcoming innovative and critical approaches.

Requirements for Authors

1. The manuscript should be original, and has not been published previously. Please don't submit material that is currently being considered by another journal.
2. Manuscripts may be 3000-8000 words or longer if approved by the editor, including abstract, text, tables, footnotes, appendixes, and references. The title should not be exceeding 15 words, and abstract should not be exceeding 150 words. 3-8 keywords or key phrases are required.
3. The manuscript should be in MS Word format, submitted as an email attachment to our email address.
4. The preferred format is encapsulated postscript (.eps) for line figures and .tif for halftone figures with a minimum resolution of 300 dpi (dots per inch).
5. Author will receive 1 copy of the issue of the journal containing their article.
6. Authors need to pay publication fee after the paper has been accepted by the journal.

Peer Review Policy

The Journal of Energy and Power Engineering is a refereed journal. All research articles in this journal undergo rigorous peer review, based on initial editor screening and anonymised refereeing by at least two anonymous referees.

Editorial Procedures

All papers considered appropriate for this journal are reviewed anonymously by at least two outside reviewers.

The review process usually takes 2-3 weeks.

Papers are accepted for publication subject to no substantive, stylistic editing.

The Editor reserves the right to make any necessary changes in the papers, or request the author to do so, or reject the paper submitted.

A copy of the edited paper along with the first proofs will be sent to the author for proofreading.

They should be corrected and returned to the Editor within seven days.

Once the final version of the paper has been accepted, authors are requested not to make further changes to the text.

Contact energy@davidpublishing.org, energy@davidpublishing.com, energy-power@hotmail.com or energy@davidpublisher.com

Paper Status Tracking >>



- Notice**
- About This Journal
 - Editorial Board Members
 - Reviewers
 - Guidelines
 - Publication Ethics Statement
 - Indexing
 - Submission
 - Subscription



>>

This work is licensed under a Creative Commons Attribution-NonCommercial 4.0 International License

-  Facebook
-  Twitter
-  LinkedIn

Journals

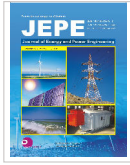

Journal of Energy and Power Engineering

ISSN: 1934-8975 (print) 1934-8983 (online)

Website: <http://www.davidpublisher.com/Home/Journal/JEPE>

Frequency: bimonthly

Volume 16, Number 3, May-June 2022 (Serial Number 163)

Submission

Subscription

Indexing

- ★ Database of Cambridge Science Abstracts (CSA), USA
- ★ Ulrich's International Periodicals Directory, USA
- ★ Chinese Database of CEPS, American Federal Computer Library Center (OCLC), USA
- ★ Chemical Abstracts Service (CAS)
- ★ CNKI
- ★ Google Scholar
- ★ RoMEO
- ★ Electronic Journals Library
- ★ AcademicKeys
- ★ CiteFactor (USA)
- ★ getCITED
- ★ Newjour
- ★ INNO SPACE
- ★ SJournals

Journal of Energy and Power Engineering

Volume 10, Number 6, June 2016 (Serial Number 103)

Contents

Clean and Sustainable Energy

- 335 **A Novel Method for Producing Hydrogen from a Hydrocarbon Liquid Using Microwave In-liquid Plasma**
Andi Amijoyo Mochtar, Shinfuku Nomura, Shinobu Mukasa, Hiromichi Toyota, Kohji Kawamukai, Kojiro Uegaito and Fadhli Syahril
- 343 **Performance Evaluation of Spark Ignited Engine Fueled with Gasoline-Ethanol-Methanol Blends**
Mohammed Kamil and Ibrahim Thamer Nazzal
- 352 **Impact Pressure Distribution in Flat Fan Nozzles for Descaling Oil Wells**
Abubakar Jibrin Abbas, Ghasem Ghavami Nasr, Amir Nourian and Godpower Chimagwu Enyi
- 358 **Blur Invariant Image Forgery Detection Method Using Local Phase Quantization**
Beste Ustubioglu, Elif Baykal, Gul Muzaffer and Guzin Ulutas

Power and Electronic System

- 364 **Improving Fuel Diesel Efficiency Using Fuel Filter**
Tatun Hayatun Nufus, Dianta Mustofa Kamal and Sri Lestari Kusumastuti
- 368 **Testing Performance of Low Voltage Arresters**
Waluyo and Yan Maret Hutasoit
- 378 **Real Time Hotspot Detection System Using Scan-Method for PV Generation System**
Kazutaka Itako, Bakhsh Hossam, Tsugutomo Kudoh and Qixin Huang

Journals

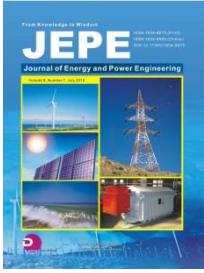

[Journal of Energy and Power Engineering](#)

ISSN: 1934-8975 (print) 1934-8983 (online)

Website:<http://www.davidpublisher.com/Home/Journal/JEPE>

Frequency: bimonthly

Volume 16, Number 5, Sept.-Oct. 2022 (Serial Number 165)

- [2016](#)

- Issue:

- [6](#)

[Open Access](#)

[A Novel Method for Producing Hydrogen from a Hydrocarbon Liquid Using Microwave In-liquid Plasma](#)

Andi Amijoyo Mochtar^{1,2}, Shinfuku Nomura¹, Shinobu Mukasa¹, Hiromichi Toyota¹, Kohji Kawamukai¹, Kojiro Uegaito¹ and Fadhli Syahril^{1,3}

[Abstract](#) | [References](#) [Full-Text PDF](#) [XML](#) **1006** Views

DOI:10.17265/1934-8975/2016.06.001

[Open Access](#)

[Performance Evaluation of Spark Ignited Engine Fueled with Gasoline-Ethanol-Methanol Blends](#)

Mohammed Kamil¹ and Ibrahim Thamer Nazzal²

[Abstract](#) | [References](#) [Full-Text PDF](#) [XML](#) **914** Views

DOI:10.17265/1934-8975/2016.06.002

[Open Access](#)

[Impact Pressure Distribution in Flat Fan Nozzles for Descaling Oil Wells](#)

Abubakar Jibrin Abbas, Ghasem Ghavami Nasr, Amir Nourian and Godpower Chimagwu Enyi

[Abstract](#) | [References](#) [Full-Text PDF](#) [XML](#) **913** Views

DOI:10.17265/1934-8975/2016.06.003

[Open Access](#)

[Blur Invariant Image Forgery Detection Method Using Local Phase Quantization](#)

Beste Ustubioglu, Elif Baykal, Gul Muzaffer and Guzin Ulutas

[Abstract](#) | [References](#) [Full-Text PDF](#)  [XML](#) **1046** Views

DOI:10.17265/1934-8975/2016.06.004

[Open Access](#)

[Improving Fuel Diesel Efficiency Using Fuel Filter](#)

Tatun Hayatun Nufus^{1,2}, Dianta Mustofa Kamal² and Sri Lestari Kusumastuti³

[Abstract](#) | [References](#) [Full-Text PDF](#)  [XML](#) **972** Views

DOI:10.17265/1934-8975/2016.06.005

[Open Access](#)

[Testing Performance of Low Voltage Arresters](#)

Waluyo and Yan Maret Hutasoit

[Abstract](#) | [References](#) [Full-Text PDF](#)  [XML](#) **1189** Views

DOI:10.17265/1934-8975/2016.06.006

[Open Access](#)

[Real Time Hotspot Detection System Using Scan-Method for PV Generation System](#)

Kazutaka Itako, Bakhsh Hossam, Tsugutomo Kudoh and Qixin Huang

[Abstract](#) | [References](#) [Full-Text PDF](#)  [XML](#) **1855** Views

DOI:10.17265/1934-8975/2016.06.007

Publication Information:

Journal of Energy and Power Engineering is published monthly in hard copy (ISSN 1934-8975) and online (ISSN 1934-8983) by David Publishing Company located at 616 Corporate Way, Suite 2-4876, Valley Cottage, NY 10989, USA.

Aims and Scope:

Journal of Energy and Power Engineering, a monthly professional academic journal, covers all sorts of researches on Thermal Science, Fluid Mechanics, Energy and Environment, Power System and Automation, Power Electronic, High Voltage and Pulse Power, Sustainable Energy as well as other energy issues.

Editorial Board Members:

Prof. Ramesh K. Agarwal (USA), Prof. Hussain H. Al-Kayiem (Malaysia), Prof. Zohrab Melikyan (Armenia), Prof. Pinakeswar Mahanta (India), Prof. Carlos J. Renedo Estébane (Spain), Prof. Mohamed Ahmed Hassan El-Sayed (Trinidad and Tobago), Prof. Carlos Redondo Gil (Spain), Prof. Roberto Cesar Betini (Brazil), Prof. Rosário Calado (Portugal), Prof. Dr. Ali Hamzeh (Germany), Prof. Noor-E-Alam Ahmed (Australia), Prof. E. Ubong (USA), Prof. Shripad T. Revankar (USA), Prof. Almoataz Youssef Abdelaziz (Egypt), Prof. Guihua Tang (China), Prof. Mohammad Rasul (Australia), Prof. Rene Wamkeue (Canada), Prof. Ya-Ling He (China), Prof. Filippo de Monte (Italy), Prof. Masoud Rokni (Denmark), Prof. Hosni I. Abu-Mulaweh (USA), Prof. Quan Zhang (China), Prof. Peng-Sheng Wei (Taiwan), Prof. Vinod Kumar (India), Prof. Yuan-Kang Wu (Taiwan), Dr. Kaige Wang (USA), Dr. Fude Liu (Hong Kong), Prof. Isa Salman Hasan Qamber (Bahrain), Dr. GM Shafiqullah (Australia), Dr. Kelum Gamage (UK), Dr. Isam Janajreh (UAE), Prof. Marco Casini (Italy), Prof. Meicheng Li (China).

Manuscripts and correspondence are invited for publication. You can submit your papers via Web Submission, or E-mail to [energy@davidpublishing.com](mailto:energy@ davidpublishing.com) or info@davidpublishing.com. Submission guidelines and Web Submission system are available at www.davidpublisher.com.

Copyright©2016 by David Publishing Company and individual contributors. All rights reserved. David Publishing Company holds the exclusive copyright of all the contents of this journal. In accordance with the international convention, no part of this journal may be reproduced or transmitted by any media or publishing organs (including various websites) without the written permission of the copyright holder. Otherwise, any conduct would be considered as the violation of the copyright. The contents of this journal are available for any citation. However, all the citations should be clearly indicated with the title of this journal, serial number and the name of the author.

Abstracted / Indexed in:

Database of EBSCO, Massachusetts, USA
Database of Cambridge Science Abstracts (CSA), USA
Chinese Database of CEPS, American Federal Computer Library Center (OCLC), USA
Chinese Scientific Journals Database, VIP Corporation, Chongqing, China
CNKI (China National Knowledge Infrastructure), China
Ulrich's Periodicals Directory
Summon Serials Solutions
Chemical Abstracts Service (CAS)
ProQuest
Google Scholar

Subscription Information:

Price: Print \$800 (per year), Online \$600 (per year), Print and Online \$880 (per year).

Editorial Office:

616 Corporate Way, Suite 2-4876, Valley Cottage, NY 10989, USA.
Tel: 1-323-984-7526, 001-323-410-1082; Fax: 1-323-984-7374; 323-908-0457
E-mail: energy@davidpublishing.com; energy@davidpublishing.org; energy-power@hotmail.com;
energy@davidpublishing.net; order@davidpublishing.com
Digital Cooperative Company: www.bookan.com.cn



David Publishing Company
www.davidpublisher.com

Paper Status Tracking >>



Notice

About This Journal

Editorial Board Members

Reviewers

Guidelines

Publication Ethics Statement

Indexing

Submission

Subscription



This work is licensed under a Creative Commons Attribution-NonCommercial 4.0 International License

Facebook

Twitter

LinkedIn

Journals

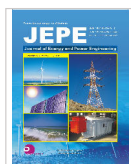

Journal of Energy and Power Engineering

ISSN: 1934-8975 (print) 1934-8983 (online)

Website: <http://www.davidpublisher.com/Home/Journal/JEPE>

Frequency: bimonthly

Volume 16, Number 3, May-June 2022 (Serial Number 163)

Submission

Subscription

Editorial Board Members

- Prof. Shripad T. Revankar (School of Nuclear Engineering, Purdue University, USA)
- Prof. René Wamkeue (UNIVERSITY OF QUEBEC AT ABITIBI-TEMISCAMINGUE, Canada)
- Prof. Tang Gui-Hua (School of Energy and Power Engineering, Jiaotong University, China)
- Prof. Maria do Rosário Alves Calado (University of Beira Interior, Portugal)
- Prof. N.A. Ahmed (University of New South Wales, Australia)
- Prof. Hussain H. Al-Kayiem (Mechanical Engineering Department, Universiti Teknologi PETRONAS (UTP), Malaysia)
- Prof. Zorhab Melikyan (HVAC Department at Yerevan State University of Architecture and Construction, Armenia)
- Prof. Ramesh K. Agarwal (Washington University, USA)
- Prof. Ali Hamzeh (Faculty of Mechanical and Electrical Engineering, Damascus University, Damascus, Syria)
- Dr. Mohammad Rasul (Central Queensland University, Australia)
- Prof. Almoataz Youssef Abdelaziz (Ain Shams University, Egypt)
- Prof. E.U. Ubong (Mechanical Engineering Department , Kettering University, USA)
- Prof. Yaling He (Xi'an Jiaotong University, China)
- Dr. Filippo de Monte (Mechanical Engineering at University of Lchar, Italy)
- Prof. Isa Salman Hasan Qamber (Department of Electrical and Electronics Engineering, University of Bahrain, Bahrain)
- Prof. Ossama Gouda (Department of Electrical Engineering, Cairo University, Egypt)
- Prof. Hosni I. Abu-Mulaweh (Mechanical Engineering, Purdue University at Fort Wayne, USA)
- Dr. Fude Liu (The University of Hong Kong, Hong Kong SAR, China)
- Dr. Alireza Maheri (Northumbria University, UK)
- Prof. Zhang Quan (Hunan University, China)
- Prof. Peng-Sheng Wei (National Sun Yat-Sen University, China)
- Dr. Shangfeng Du (University of Birmingham, UK)
- Dr. GM Shafiuallah (Senior Lecturer, Murdoch University, Australia)
- Dr. Kaige Wang (Iowa State University, Ames, IA, USA)
- Dr. Jordan Radosavljević (University of Pristina, Serbia)
- Dr. Yuhua Duan (DOE-National Energy Technology Laboratory, USA)
- Prof. Yaxin Su (Donghua University, Shanghai, China)
- Prof. Vinod Kumar (GGS Indraprastha University, India)
- Prof. Yuan-Kang Wu (National Chung-Cheng University, Taiwan)
- Prof. Ahmed Abd El-Moneim (Egypt-Japan University of Science and Technology, Egypt)
- Prof. Adel Mourtada (Faculty of Engineering of the Lebanese University, USA)
- Prof. Xudong Zhao (University of Nottingham, UK)
- Prof. Meicheng Li (North China Electric Power University, China)
- Prof. Marco Casini (SAPIENZA University of Rome, Italy)
- Dr. Isam Janajreh (Associate Professor Mechanical Engineering Program, Masdar Institute, UAE)
- Dr. Kelum Gamage (James Watt School of Engineering, University of Glasgow, UK)
- Dr. Sanjeevikumar Padmanaban (Electrical Engineering, University of Bologna, Italy)
- Prof. Xiao Jing Liu (Nuclear Science and Engineering, Shanghai Jiao Tong University, China)
- Associate Professor Zheng Ma (University of Southern Denmark, Denmark)
- Assistant Professor Akifumi Yamaji (Waseda University, Japan)
- prof. Wenxi Tian (Xi'an Jiaotong University, China)
- prof. Bao-Wen Yang (Xi'an Jiaotong University, China)
- Assistant Professor Mohammed Kamil (University of Sharjah, UAE)
- Prof. Angel Huminic (Transilvania University of Brasov, Romania)
- Prof. Rajapakse Mudiyansele Gamage Rajapakse (University of Peradeniya, Sri Lanka)
- Tahir M. Lazimov (Azerbaijan Technical University, Azerbaijan)
- Geoffrey Scott Rothwell (Organisation for Economic Cooperation and Development, Nuclear Energy Agency, Nuclear Development Division, France)
- Yang Yang (University of Central Florida, USA)
- Rui Melicio (University of Lisbon, Portugal)
- Serdar Celik (Southern Illinois University, Edwardsville, USA)
- Ebrahim Babaei (University of Tabriz, Iran)
- Shahram Javadi (AZAD University, Iran)
- Rahul R. Bhosale (Qatar University, Qatar)
- ANAND KUMAR (Qatar University, Qatar)
- Nachal Devi Subramanian (Rutherford Appleton Laboratory, UK)
- Shuai Tan (Oak Ridge National Laboratory, USA)
- Emma Frosina (University of Naples "Federico II", Italy)
- Malek Tabbal (American University of Beirut, Lebanon)
- Prof. Dr. Imdat Taymaz (Sakarya University, Turkey)
- Shahram Javadi (AZAD University, Iran)
- Rahul R. Bhosale (Qatar University, Qatar)
- Anand Kumar (Qatar University, Qatar)
- Nachal Devi Subramanian (Rutherford Appleton Laboratory, UK)
- Shuai Tan (Oak Ridge National Laboratory, USA)
- Emma Frosina (University of Naples "Federico II", Italy)
- Malek Tabbal (American University of Beirut, Lebanon)
- Imdat Taymaz (Sakarya University, Turkey)
- Sezgin Ersoy (Marmara University, Turkey)
- Zhiyong Tian (China Academy of Building Research, China)
- Wei Li (West Virginia University, USA)

Kitessa Roro (CSIR Energy Centre, South Africa)
Dr. Mohammad Moghimi Ardekani (University of Pretoria, South Africa)
Xiangning Meng (Northeastern University, China)
Yingchen Yang (University of Texas, USA)
Amir Mehmood (University of Engineering and Technology Lahore, Pakistan)
Jisheng Zhang (Hohai University, China)
Salah KAMEL (Aswan University, Egypt)
Zine Ghemari (University Mohamed Boudiaf- M'sila, Algeria)
Dr Sanghyun Lee (Indiana State University, USA)
Ricardo Zavala-Yoé (University of Groningen, The Netherlands)
Ph.D. Yueping Fang (Coventry Univesity, China)
Francesco D'Auria (University of Pisa, Italy)
Dr Ayman Attya (Ph.D., Wind Energy & Control Centre –University of Strathclyde, UK)
E.Colombo (Associate Professor, Department of Energy, Politecnico di Milano, Italy)
Dongwhi Choi (Ph.D., Research Assistant Professor, Pohang University of Science and Technology (POSTECH), Korea)
Sanjay Kumar (Ph.D., Bhabha Atomic Research Centre, Mumbai-India)
Professor Farid Nasir bin Ani (Universiti Teknologi Malaysia)
EBRAHIM ABOUZARI-LOTF (Ph.D., Center for Hydrogen Energy, Institute of Future Energy, International Campus, Universiti Teknologi Malaysia, Malaysia)
Huseyin SANLI (Ph.D., Kocaeli University – Ford Otosan Automotive Vocational School, Golcuk/Kocaeli/Turkey)
Dr. K. SRINIVAS REDDY (Professor, Heat Transfer & Thermal Power Laboratory, Indian Institute of Technology Madras, India)
Dr. Rose Marie O. Mendoza (President & Chief Science Officer Chairman of the Board, Mark-Energy Revolution Corporation)
Ephraim Suhir (Ph.D. , Bell Laboratories, Physical Sciences and Engineering Research Division, Murray Hill, NJ, USA (ret);Portland State University, Depts. of Mech. and Mat., and Elect. and Comp. Engineering, Portland, OR, USA; James Cook University, Mackay Institute of Research and Innovation, Townsville, Queensland, Australia; and ERS Co., 727 Alvina Ct., Los Altos, CA 94024, USA)

Paper Status Tracking >>

- Notice**
- About This Journal
 - Editorial Board Members
 - Reviewers
 - Guidelines
 - Publication Ethics Statement
 - Indexing
 - Submission
 - Subscription

 >>

This work is licensed under a Creative Commons Attribution-NonCommercial 4.0 International License

- Facebook
- Twitter
- LinkedIn

Journals

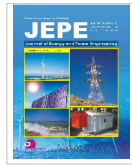

Journal of Energy and Power Engineering

ISSN: 1934-8975 (print) 1934-8983 (online)

Website: <http://www.davidpublisher.com/Home/Journal/JEPE>

Frequency: bimonthly

Volume 16, Number 3, May-June 2022 (Serial Number 163)

Submission

Subscription

Reviewers

- Dr. Xin Jing
Motor Control Engineer, General Motors Advanced Technology Center, USA
- Dr. Alireza Maheri
Faculty of Engineering and Environment, Northumbria University, UK
- Dr. A. Mete VURAL
Department of Electrical and Electronics Engineering
Faculty of Engineering
University of Gaziantep, Gaziantep, Turkey
- Dr. Vasilija Sarac
Rudi Caevac, 8/59, 1000 Skopje, Macedonia
- Dr. Diego Arnone
Engineering Ingegneria Informatica SPA, Italy
- Dr. Ahmed Mohamed Ali ElSheikh
Mechanical Engineering Department, South Valley University, Egypt
- Dr. Mingyao Xu
Senior Engineer, Reserch, PH.D.
Technology Research Center, Sumitomo Heavy Industries, Ltd., Japan
- Prof. Dr. A.M. Sharaf
School of Science and Engineering, Habib University, Karachi, Pakistan
- Mahmoud E. ALI
Department of Electrical Engineering, Faculty of Engineering (at Shoubra), Benha University, Egypt
- Habib BEN BACHA
Salman bin Abdul-Aziz University - College of Engineering at Alkharj, Arabia
- Prof. Dr. Ahmed Farouk Abdel Gawad
Professor of Computational Fluid Mechanics, Mechanical Power Engineering Department,
Faculty of Engineering, Zagazig University, Zagazig, Egypt
- Dr. Mohamed Ibrahim Mosaad
Dept. of Electric power and machines, Yanbu Industrial college (YIC) , Saudi Arabia
- Dr. V'yacheslav (Slava) Akkerman
West Virginia University, USA
- Svitlana Alyokhina
A.N.Podgorny Institute for Mechanical Engineering, Department of Modeling and Identification Thermal Processes,
Ukraine
- Dr. Munkhbayar Batmunkh
School of Chemical Engineering, The University of Adelaide, Adelaide 5005, South Australia, Australia
- Dr. Zahra Mirbagheri
Electro Manufacturing University of Malaya, Malaysia
- Dr. De Blasio Cataldo
Department of Energy Technology, Aalto University School of Engineering, Finland
- Dr. Kassai Miklos
Faculty of Mechanical Engineering, Budapest University of Technology and Economics, Hungary
- Prof. Patrick Lemieux
Bently Professor of Mechanical Engineering
California Polytechnic State University, San Luis Obispo, San Luis Obispo, CA 93407, USA
- Dr. ...

Dr. Pedram Hanalizadeh
Assistant Professor
School of Mechanical Engineering, College of Engineering, University of Tehran, Tehran, Iran

Dr. Seyyed Sadegh Mottaghian
Department of Electrical engineering and Computer Science, South Dakota State University, USA

Professor Mihail Antchev
Department of Power Electronics, Technical University – Sofia, Bulgaria

Cheng (Wallace) Zhou
Department of Chemical Engineering, University of Newcastle, Australia

Professor Dato' Dr Hj. Rosli Bin Abu Bakar
Fakulti Kejuruteraan Mekanikal, Universiti Malaysia Pahang, Malaysia

Prof. H.I. Abu-Mulaweh
Professor of Mechanical Engineering, Purdue University at Fort Wayne, USA

Dr. Fernanda Pinheiro Martins
Aeronautical Technology Institute, ITA, São José dos Campos, SP, 12345-678, Brazil

Anele Amos Onyedikachi
LISV Laboratory, Université de Versailles ST-Quentin-En-Yvelines, Paris, France

Kunjal Yagnik
Ph.D. Electrical and Computer Engineering, Iowa State University Ames, U.S.A.

Ibrahim Udale Hussaini
International Islamic University Malaysia

Prof. Alexander Beshta
Doctor of sciences, professor, National Mining University, Ukraine

Dr. Eman Saad A.Einaby Ahmed
Assistance Professor of Electrical Engineering Department, Faculty of Engineering, Kafrelsheikh University, Egypt

Dr. Gamal M. Hashem
Associate Professor in the Department of Electrical Power and Machines, Ain Shams University, Egypt

Pooya Hosseini
Chemical & Biological Engineering Department, The University of British Columbia, Canada

Dr. Olivian Chiver
Technical University of Cluj Napoca, North University Center of Baia Mare, Romania

Prof. NABIL NGOTE
"Professeur Habilité" Degree, Ecole Mohammadia d'Ingénieurs, Rabat, Morocco

Manoel Antonio da Fonseca Costa Filho
University of the State of Rio de Janeiro, Thermoscience and Energy Laboratory, Brazil

Dr. Mahdi Rezaei
Iran University of Science & Technology Tehran, Iran

Yannick Deshayes
Université de Bordeaux | Bordeaux, France

Mr. Nikhilkumar Shah
Centre for Sustainable Technologies, University of Ulster, UK

Atul Sagade
New Satara collage of engineering & Management, India
Valentin Gyurov
Assistant Professor in Technical University - Varna, Department of Electric Power Supply and Electrical Equipment, Bulgaria

Prof. Jorge Servert del Río
Escuela Técnica Superior de Ingenieros Industriales, Madrid, Spain

Janine Bruchmann
SWK-Energiezentrum E2 der Hochschule Niederrhein
Lehr- und Forschungszentrum für Energiemanagement und Energietechnik, Germany

Mohammad Ali Ashjari
Islamic Azad University Jofa International Branch, Jofa, Iran

Dr. Xiansen Li
Device Research Laboratory (DRL), Department of Mechanical Engineering, Massachusetts Institute of Technology (MIT), USA

Mr. Kusang Sherpa
Kathmandu University, Nepal

Dr. Thuy Nguyen Ba
National Centre for Hydrometeorological Forecasting, Vietnam

Dr. Michal Wierzbowski
Institute of Electrical Power Engineering, Lodz University of Technology, Poland

Kianoosh Yousefi
Mechanical Engineering – Energy Conversion, Islamic Azad University, Iran

Dr. Krešimir Fekete
Faculty of Electrical Engineering, University of Osijek, Croatia

Maher.Saab.Salamah
Combined power plant and energy, Mosul University, Iraq

Xiaolu Wang
Senior Engineer, The First Research Institute, China Academy of Aerospace Aerodynamics, China

Professor BUI VAN GA
Doctor of Ecole Centrale de Lyon
Engineer of Mechanical Engineering
Prize: Science-Technology of the French Speaking Universities Agency (AUF) in 2003

Sunil Kedia
High Efficiency Specialist Research Team, PASL, Global R&D Center, Crompton Greaves Ltd., Kanjur Marg (EAST),
India

Dr. Napayalage Aruna Kithsiri Nandasena
PhD in Hydrodynamics and Coastal Engineering, Saitama University, Japan

Behzad Bigdeli
Principal and Founder, Exponential Advisor, Århus, Denmark, Beijing & Fort Worth, TX

Dr. Verónica Bermúdez Benito
Senior Scientist, NEXCIS Photovoltaic Technology, France

Zicmane Inga
Riga Technical university, Faculty of Power and Electrical Engineering, Latvia

Rajesh V. Shende
Assistant Professor
Department of Chemical and Biological Engineering, South Dakota School of Mines and Technology, Rapid City, USA

Dr. Błażej Olek
Institute of Electrical Power Engineering, Faculty of Electrical, Electronics, Computer and Control Engineering,
Lodz University of Technology, Poland

Dr. Hossein Mohammadpour
Postdoctoral Fellow,
University of South Carolina, Department of Electrical Engineering, 301 S. Main Street, Columbia SC 29208, USA

Dr. Jianping Wang
Senior Principle Scientist on AC/DC Power System Protection, ABB Corporate Research, Sweden

Mr. Natthaphon Phokhaphan
Research Laboratory in Power Electronics, Department of Electrical Engineering, Khon Kaen University, Thailand
Prof. Mohammad Mehdi Rashidi
Bu-Ali Sina University, Hamedan, Iran

Dr. Euy-Joon LEE
Adjunct Professor, Head of RE (Renewable Energy) division in UST (University of Science & Technology), Korea

Dr. Yousif Al Mashhadany
University of Malaya, Power Energy Dedicated Advanced Centre (UMPEDAC), Malaysia

Prof. Gabriel Negreanu
University Politehnica of Bucharest, Faculty of Mechanical Engineering, Romania

Dr. Aldo Belardi
PhD in Electrical Engineering, Universidade de São Paulo, USP, Brazil

Dr. João Carlos O. Matias
Department of Electromechanical Engineering, University of Beira Interior, Portugal

Dr. Hyun Jung Kim
National Institute of Aerospace, Korea

Prof. Dr. Marwan M. Mahmoud
An Najah National University, P.O.Box 721, Nablus- West Bank, Palestine

Prof. Dr. Masaki Ozawa
Professor, Tokyo Institute of Technology, Research Laboratory for Nuclear Reactors, Japan

Shiva Adireddy
University of New Orleans, New Orleans, LA, USA

Dr. Mohammad Taleghani
PhD on Thermal Comfort in Courtyard Buildings, Delft University of Technology, Delft, the Netherlands

Dr. Ahmad M. Haddad
Birzeit University, Ramallah, Palestine

Dr. Ming Yang
University of California, Berkeley, USA

Dr. Ahmed M. Gaouda
Associate Prof.
Electrical Engineering Department, Faculty Of Engineering, United Arab Emirates University, United Arab Emirates

Deepak Prasad
Assistant Lecturer, Mechanical Engineering, School of Engineering and Physics, Faculty of Science, Technology and Environment, University of the South Pacific, Laucala Campus, Suva, Fiji

Oureste Elias Batista
Department of Electrical and Computer Engineering, University of São Paulo, São Carlos, SP, BR, 13566-590, Brazil

Amir Zacarias Mesquita
Centro de Desenvolvimento da Tecnologia Nuclear - CDTN, Comissão Nacional de Energia Nuclear - CNEN, Brazil

Babak Vajdi Hokmabad
Department of Mechanical Engineering, University of Alberta, Edmonton, Canada

Dr. M.Y. Abdollahzadeh Jamalabadi
assistant professor,
faculty of mechanical engineering, Chabahar maritime university, Chabahar, Sistan & Baluchestan 19395-1999, Iran

Mr Lukasz Knypinski
Poznan University of Technology, Electrical Engineering Faculty, Poland

Dr. Arno Eichberger
Institute of Automotive Engineering, Graz University of Technology, Austria

Chowdhury Akram Hossain
EEE Department of American International University - Bangladesh(AIUB)

Prof. Dr. TAMRAKAR INDRAMAN
Ph. D. in Electrical Engineering from, Institute of Engineering, T.U., Nepal

Dr. Giovanni Angrisani
University of Naples Federico II, Italy

Dr. Iryna Gryshanova
Associate professor
National Technical University of Ukraine "Kyiv Polytechnic Institute" Kyiv, Ukraine

Dr. Ray-Hua Horng
Graduate Institute of Precision Engineering, National Chung Hsing University Taichung 402, Taiwan

Prof. El-Hadi BENYOUSSEF
National Polytechnic School - Department of Chemical Engineering
Unit Research in Engineering and Environment, Algeria

Dr. Nadheer A. Shalash
Faculty of Electrical and Electronics Engineering, University Malaysia Pahang, 26600 Pekan, Malaysia

Miss Tianshu Zhang
Electrical Engineer in International Organization Division, International Cooperation Department, China Electric Power Research Institute (CEPRI), Beijing, China

Rafik Tharwat Labib
Ain Shams University, Cairo, Egypt

Dr. Panagiotis Tsekouras
NATIONAL TECHNICAL UNIVERSITY OF ATHENS, Greece

Dr. Enes YAŞA
Istanbul Technical University- Department of Architecture-Building Science, Turkey

Kaisar R. Khan
Assistant Professor (EE)
McNeese State University Lake Charles, LA 70605, USA

Mr Jackson John Justo
Division of Electronics & Electrical Engineer, Dongguk University-Seoul, 26, Pil-dong 3-ga, Jung-gu, Seoul 100-715, Korea

Dr. Miloš Tanasijević
Associate Professor, University of Belgrade - Faculty of Mining and Geology

Dr. GM Shafiqullah
Senior Lecturer, Murdoch University, Australia

Dr. Bernard Michael
Kyushu Institute of Technology, Japan

Dr. Wenzhong Zhou
Department of Mechanical and Biomedical Engineering, City University of Hong Kong

Dr. Liviu Neamt
lecturer, doctor in electrical engineering, Head of the Department of Electrical and Electronic Engineering and Computers,
Faculty of Engineering, North University Centre of Baia Mare, Technical University of Cluj-Napoca, Romania

Dr. Janardan Prasad Kesari
ASSOCIATE PROFESSOR.
Mechanical Engineering Deptt., Delhi Technological University, Bawana Road, Delhi-110042, India

Dr. Guilherme Filippo Filho
Associate Professor
UNESP – Universidade Estadual Paulista
Department of Energy, Campus Guaratinguetá
Expertise: Energy Efficiency
Brazil

Dr. Felix Toepler
Fka (Forschungsgesellschaft Kraftfahrwesen mbh Aachen), Germany

Dr. Hesham Abdou
Faculty of Engineering – Cairo University, Egypt

Dr. Zeynep Deniz EYGI
Faculty of Engineering – Cairo University, Egypt
Middle East Technical University (METU), Physics Department, Ankara, Turkey

Dr. Jaroslaw Krzywanski
Czestochowa University of Technology, Institute of Advanced Energy Technologies, Poland

Dr. Gilberto Carrillo Caicedo
Director Maestría en Sistemas Energéticos Avanzados
Universidad de Santander, Bucaramanga, Colombia

Prof. Roberto Cesar Betini
professor member of the Electrotechnic Academic Department of the Federal Technological University of Paraná., Brazil

Dr. Arman Sargolzaei
Florida International University, USA

Dr. Kamal Radi
LDC, Abu Dhabi Transmission and Dispatch Company, Transco, Abu Dhabi, UAE

Dr. Amirhossein Sajadi
Department of Electrical Engineering and Computer Science
Case Western Reserve University, USA
Vahid Rezaei
Department of Electrical Engineering and Computer Science (Brown Building), Colorado School of Mines, USA

Dr. Douglas Ricardo Slaughter Nyimi
Ph.D. in Electric Power Systems
Escola Politécnica da Universidade de São Paulo, Brazil

Mr Alireza Raghani
Department of Electrical Engineering, Shahid Abbapour Technological Campus, Shahid Beheshti University, Iran

Dr. Romanas Savickas
Energy and Thermal engineering at Vilnius Gediminas Technical University (VGTU), Republic of Lithuania

Dr. Saher Umer
School of Information Science, Japan Advanced Institute of Science and Technology (JAIST), Ishikawa, Japan

Dr. Xifei Li
School of Physics and Material Science & Center of Clean Energy and Materials,
Tianjin Normal University No.393, Binshui West Road, Xi Qing District, Tianjin City, China

Dr. Lucian Petrescu
University POLITEHNICA from Bucharest 313, Splaiul Independentei, 060042 Bucharest, Romania

Dr. Annukka Santasalo-Aarnio
Department of Materials Science, Aalto University, Finland

Dr. Emil CAZACU
Associate Professor – Reader (since 2008)
Polytechnic University of Bucharest- 313, Splaiul Independentei, 060042, Bucharest, Romania

Dr. Eman Abdel-Hakim Tora
postdoctoral researcher, Centre for Renewable and Sustainable Energy studies (CRSES), Stellenbosch University,
South Africa

Prof. Oscar David Florez Cediel
Professor at the Universidad Distrital Francisco José de Caldas, USA

Dr. Khor Chu Yee
School of Mechanical Engineering, Engineering Campus, Universiti Sains Malaysia, 14300 Nibong Tebal, Openang,
Maylaysia

Dr. Rafika Mestiri
Ph. D. (Energy Engineering)
Ecole Nationale d'Ingénieurs de Monastir, Tunisia

Dr. K.R.Vadivelu
Assistant Professor, Annamacharya Institute of Technology and Sciences, India

Dr. José Rubens Maiorino
Universidade Federal do ABC, Centro de Engenharia, Modelagem e Ciências Sociais Aplicadas, Brasil

Professor Dr. Mohammed M. Shabat
Physics Department, Islamic University of Gaza, P.O.Box 108, Gaza, Gaza Strip, Palestinian Authority

Dr. Carlos Frederico Mattos Schettin
Federal Fluminense University, Brazil

Dr. Luis C. Origa de Oliveira
Brazilian Nuclear Industries, Brazil

Prof. Marcelo Silva Stheil
Universidade Estadual do Norte Fluminense- UENF, Brazil

Dr. Mohammad Javad Sanjari
FACTS RESEARCH Lab., Ground Floor, Electrical Engineering
Department, Abou-Ray-Han Building, Amirkabir University of
Technology (Tehran Polytechnic), Hafez Ave, Tehran 15914, Iran

Dr. Bilal Babar
Junior Engineer
Pakistan Council of Scientific and Industrial Research (PCSIR) Mastung Road, Quetta, Pakistan

Dr.V. Ganesh
Associate Professor & HEEED, JNTUA College of Engineering, Pulivendula, India

Dr.Jin Xuan
Assistant Professor, School of Engineering and Physical Science, Heriot-Watt University, Edinburg, U.K.

Dr. Miguel Pires Amado
Researcher and Professor in Development, Sustainable Urban Planning and Sustainable Architecture
Travessa Instituto dos Ferroviários Sul e Sueste, PORTUGAL

Mr Sameer Mahmoud Al-Dahidi
Department of Energy, Nuclear Division, Leonardo Campus, Italy

Songbai CHENG
Postdoctoral fellow, Kyushu University (Japan), Researcher in Japan Atomic Energy Agency, Japan

Gurakuq Dajaku
FEAM GmbH, University of Federal Defence Munich, 85577 Neubiberg, Germany

Kiran Tota-Maharaj
Institute of Infrastructure and Environment, School of Engineering, University of Edinburgh, Scotland U.K.

Dr. Denver Cheddie
Assistant Professor,
Centre for Engineering Systems (Mechanical Engineering), Centre for Energy Studies, University of Trinidad and Tobago

Aleksandar S. Andelkovic
teaching assistant, Faculty of Technical Sciences Novi Sad, Serbia

Ciprian Sorandaru
Department of Electric Machines and Drives, Faculty of Electrical and Power Engineering,
POLITEHNICA University of TIMISOARA, Romania

Grigoras Gheorghe
Senior Lecturer,
Electrical Engineering Faculty, Power System Department, "Gheorghe Asachi" Technical University of Iasi, Romania

Dr. Julio C. Gómez Mancilla
LUGAR DE NACIMIENTO: Colima, Colima. México

Abdelkader HADIDI
Ingénieur d'état principal au niveau de la Direction Centrale (Ministère Des Ressources En Eau)
Direction de l'Assainissement et de la, Algérienne

Gour Chand Mazumder
University of Dhaka, Bangladesh

Dr. Xiaojing Liu
School of Nuclear Science and Engineering, Shanghai Jiao Tong University, China

Dr. Ziliang Zheng
Wayne State University, USA

Dr. Ashokumar M Sharma
Iowa State University, Ames, Iowa, USA

Dr. Siyamak SARABI
Ecole nationale supérieur Arts et Métiers ParisTech (ENSAM), France

Dr. Alessandro Serpi
Department of Electrical and Electronic Engineering, University of Cagliari, Italy

Dr. Mario Porru
University of Cagliari, Department of Electrical and Electronic Engineering, Italy

Dr. Nazanin Naderi
Wayne State University, USA

Suhas Jain Suresh
Guest Researcher,
Department of Computational fluid dynamics, Institute of Fluid Dynamics, Germany

Dr. Salakhova Elza Abdulaziz gizi
Doctor of chemical sciences, Azerbaijan Pedagogical University, Azerbaijan

Dr Mohammad B. Shadmand
Renewable Energy & Advanced Power Electronics Research Lab,
Department of Electrical and Computer Engineering, Texas A&M University, College Station, TX 77843 USA

Dr. Tarlis Tortelli Portela
Federal Technological University of Parana (UTFPR), Brasil

Dr. Tatsuhito AIHARA
Associate Professor, Department of Mechanical Engineering, Hosei University, Japan

Dr Reza Arababadi
Arizona State University, USA

Amani Al-Azzam
Managing Director Assistant for Operation & Planning
National Electric Power Company, Jordan

Dr. Amarjit Singh Sarpal
Ph.D. in Chemistry, from GNDU, Amritsar, India

Dr. Alicja Kazek Kesik
PhD- Silesian University of Technology
Faculty of Chemistry, Silesian University of Technology, Poland

Dr. Salwa Bouadila
Research and Technology Center of Energy,Thermal Processes Laboratory, Tunisia

Dr. Jian Gao

Dr. Raed A. Sherif
Kuwait Oil Company, Kuwait

Dr. Leonam dos Santos Guimarães
Diretor de Planejamento, Gestão e Meio Ambiente
Rua da Candelária 65 10º andar, Brazil

Dr. Ramadan El mshamer
Power system Protection & Control Chief Engineer, General Electricity Company of Libya, Libya

Dr. Mohammad Faridun Naim Tajuddin
School of Electrical Systems Engineering, Universiti Malaysia Perlis (UniMAP), Malaysia

Dr. Hatraf Nesrine
Researcher In A Research Unit : The Solar Equipments Development Unit

Dr. Chaouki Ghenai
Sustainable and Renewable Energy Engineering Department
College of Engineering
University of Sharjah, Sharjah, UAE

Dr Zhenhua Luo
Electronics and Computer Science, University of Southampto, UK

Giedrius Gecevičius
Engineer, Lithuania Energy Institute, Laboratory for Renewable Energy and Energy Efficiency, Lithuania

Dr. Dereje Shiferaw

CEng, MIMechE, Design Development Manager, England

Dr. Alireza Vali
Mechanical Engineering, University of Alberta, Edmonton, AB, Canada

Dr. Mahdaoui Toufik
Unite de recherche des materiaux emergents (U.R.M.E.S), Universite de Setif, Algeria

Dr. Hussam Jouhara
College of Engineering, Design and Physical Sciences, Brunel University, Uxbridge, UB8 3PH, UK

Mohammadreza Nematollahi
Department of Physics, Norwegian University of Science and Technology, Norway

Amir Ahadi
Mechanical Engineering, Kunsan National University, South Korea

Dr. Oyetunde Adeoye ADEAGA
Department of Mechanical Engineering, the Polytechnic, University of Ibadan, Nigeria

Pedram Asef
Electrical Engineering Department, Polytechnic University of Catalonia-BarcelonaTech, Spain

Qingshi Tu
Environmental Engineering, University of Cincinnati, USA

Shen Shou Chung
Institute of Biophotonics Engineering, National Yang Ming University, Taiwan

Dr. Zhixuan Duan
Environmental Engineering, University of California, USA

Associate Professor Tahar Tayebi
Faculty of Sciences and Technology, University of Mohamed El Bachir El Ibrahimi, Algeria

Mohammed Amine Deriche
Faculty of Hydrocarbons and Chemistry, University of Boumerdes, Algeria

Kostas Sinapis
Energy Research Center of the Netherlands

Fengxia Wang
Department of Mechanical and Industrial Engineering, Southern Illinois University Edwardsville, USA

Tanya Gachovska
Electrical Circuits III, University of Nebraska, Lincoln, USA

Amritansh Agarwal
Department of Mining Engineering, Indian School Of Mines (ISM-IIT) Dhanbad, India

Karamooz Ravari Mohammad Reza
Mechanical Engineering (Applied Mechanics), Isfahan University of Technology, Iran

The Freiburg Materials Research Centre (FMF), University of Freiburg, Germany

Mojgan Hojabri

Faculty of Electrical & Electronic Engineering, University Malaysia Pahang (UMP), Malaysia

Oana - Raluca Mănicuă

Network Development Office at CNTEE Transelectrica SA, Bucharest, Romania

Monish Ahuja

Punjab Renewable Energy Systems Pvt. Ltd. (PRESPL), India

Mohammed Abd El-Rahman El-Shorbagy

Faculty of Engineering, Menoufia University, Shebin El-Kom, Egypt

Prof. Dr. Ir. Dean Vučinić

Dept. Mechanical Engineering (MECH) & Dept. Electronics and Informatics (ETRO), Vrije Universiteit Brussel (VUB), Belgium

Professor Irine Berdenishvili

Georgian Technical University, Georgia

Navid Akar

Industrial Engineer, TC Development & Design, USA

Huojun Yang

Construction Management and Engineering Department, North Dakota State University, ND, USA

Dr. Eid S. Alatawi

Assistant Research Professor of Mechanical Engineering, National Center for Aeronautical Technology, KACST, Kingdom of Saudi Arabia

Prof. Dr. Mohamed Khayet

Chair of the Department Applied Physics I, Faculty of Physics, University Complutense of Madrid, Madrid, Spain

Dr. Saad Odeh

Senior Program Convenor (Science and Engineering), Western Sydney University - Sydney City Campus, Australia

Anukam Anthony Ike

Ph.D., Fort Hare Institute of Technology, University of Fort Hare, Alice, South Africa

Mangal Hemant Dhend

Assistant Professor in Electrical Engineering Department, A.I.S.S.M.S. College of Engineering Pune-1, India

Atanu Kumar Das

Pulp and Paper Technology, Asian Institute of Technology, Thailand

Sahand Faraji

PhD, Chemical Engineering, Istanbul Technical University, TURKEY

Pattabhi Ramaiah Budarapu

Post-doctoral, IMT School for Advanced Studies Lucca, Lucca, Italy

Federico Leon Zerpa

UNIVERSIDAD DE LAS PALMAS DE GRAN CANARIA

Mauro Mamei

Post Doc., University of Pisa, Italy

Kamil Kahveci

Professor, Mechanical Engineering Department, Faculty of Engineering, Trakya University, Turkey

Johannes Betz

Institute of Automotive Technology, Technical University Munich, Germany

Mohammad Seydali Seyf Abad

Power System Control and Dynamics Research Lab, Electrical Engineering Department, Sharif University of Technology, Iran

Yizheng Xu

Electrical and Electronic Engineering, University of Manchester, UK

Hassan Haes Alhelou

Department of Electrical Power Engineering, Tishreen University, Latakia, Syria, Iran

Chaitanya Ghodke

Department of Mechanical Engineering, Oregon State University, Corvallis, USA

Rosemizi bin Abd Rahim

Senior Lecturer, School of Computer & Communication Engineering (SCCE), Universiti Malaysia Perlis, Malaysia

Hermes Jose Loschi

Faculdade de Engenharia Elétrica e de Computação da UNICAMP, Universidade Estadual de Campinas, Brasil

Mario Blázquez

Research Institute of Industrial Economics (IFN), Sweden

Hasan Sajjadi

Ph.D., Faculty of Engineering, Bahonar University, Iran

Rishu Chaujar

Assistant Professor, Department of Engineering Physics, Delhi Technological University, Delhi, India

Levent Colak

Assistant Professor, Department of Mechanical Engineering, Başkent University, Turkey

Jun Hieng Kiat

Assistant Professor, Department of Mechanical and Material Engineering, Universiti Tunku Abdul Rahman, Kuala Lumpur, Malaysia

Amir H. Soleimanisalim

Department of Chemical and Petroleum Engineering, University of Calgary, Calgary, Alberta, Canada

Manjunatha K.

Assistant Professor, Department Of Mechanical Engineering, Rao Bahadur.Y. Mahabaleshwarappa Engineering College, India

Ji Lin

Assistant Professor, Department of Engineering Mechanics, Hohai University, China

Blaise Mempoou

Department of Architecture & Built Environment, University of Nottingham, UK

Burhan Çuhadaroğlu

Professor, Department of Mechanical Engineering, Karadeniz Technical University (KTU), Trabzon, Turkey

Parikh M. Ali

Assistant Lecturer, Electrical Department, Faculty of Engineering, University of Sulaimani, Iraq

Dr. Namrata Sengar

Assistant Professor, Department of Pure and Applied Physics, University of Kota, India

Mohamad Ghazi Droubi

Lecturer in Mechanical Engineering, Robert Gordon University, Aberdeen, UK

Dr. A. D. P. Rao

Professor & Head, Dept. of Nuclear physics, Andhra University, India

Arvi Hamburg

Dean of the Faculty, Faculty of Power Engineering, Tallinn University of Technology, Estonia

Massimiliano Lo Faro

Researcher, Italian National Council of Research - Institute for Advanced Energy Technologies (CNR-ITAE) - Messina, Italy

Fredy Ernesto Cañizares Niño

Fabio Mottola

Research Fellow, Department of Electrical Engineering and Information Technology, University of Naples Federico II, Italy

Vahid Kouh Daragh

Ph.D., University of Bologna, Italy

Duško Lukač

Senator, University of Applied Sciences, Rheinische Fachhochschule Köln gGmbH, Germany

Rabindra Prasad Dhakal

Senior Scientist, Faculty of Technology, Nepal Academy of Science and Technology, Nepal

Olga Gorte

Faculty of Power Engineering, Automated Electrical Power Systems Department, Novosibirsk State Technical University, Russia

Pavel Gantar

President (Speaker) of the National Assembly of the Republic of Slovenia, Slovenia

Panagiotis Stathopoulos

Research associate at ISTA - TU Berlin, Germany

Imtiaz Noor Bhatti

PhD, School Of Physical Sciences, Jawaharlal Nehru University, New Delhi, India

Goce Kalevski

Freelancing in many design companies

Vladimir Vaskov

Head of Rural Telephony Department in MAKPETROL-TEAS A.D. Skopje, R. Macedonia

Dr. Yushan Liu
Department of Electrical and Computer Engineering, Texas A&M University at Qatar, Doha, Qatar

Dr. Xiaoyu Cui
Photoemission, Experimental Facilities Division, Canadian Light Source, University of Saskatchewan, Canada

Dr. Jean-François SILVAIN
Adjunct Professor of Engineering at the University of Nebraska, Lincoln, USA

Rodrigo Carlos Viana Coelho
PhD in Physics, Federal University of Rio de Janeiro, Rio de Janeiro, Brazil

Vladimir Klatzkin
CTO from Israel side (Winflex, Rafael) Binational project BIRD (Israel Ministry of energy and infrastructure –USA, DOE, General Electric Co), Israel

Andras Baczoni
PhD., Chemistry & Corrosion Engineering, University of Pannonia. Power Industry Technical Consultant, Nalco, Hungary

S. Ali Ashrafizadeh
Assistant Professor, Chemical Engineering Department, Faculty of Engineering, Islamic Azad University, Dezful Branch Dezful, Iran

Etim U.Ubong
Associate Professor of Mechanical Engineering, Alternative Fuels, Aalto University (formerly Helsinki University of Technology), Helsinki, Finland

Mohannad Saleem Qurie
Assistant Professor, Environment and Earth Science Department, Collage of Science and Technology, Al-Quds University, Palestine

V. Vijaya Rama Raju
Associate Professor, Department of Electrical & Electronics Engineering, Gokaraju Rangaraju Institute of Engineering & Technology (GRIET), Hyderabad, Telangana, India

Paulo Cesar Marques de Carvalho
Departamento de Engenharia Elétrica, Centro de Tecnologia, Universidade Federal do Ceará, PICI, Brasil

Dr. Sanjeev Kumar
Ph.D., University of Science & Technology, Faridabad, India

Dan Jigoria-Oprea
Assistant Professor, Power Systems Department, Politehnica University Timisoara, Timisoara, Romania

Prof.Ass. Ilirjana Boci
Department of Industrial Chemistry, Faculty of Natural Sciences, University of Tirana, Tirana, Albania

Mbarek Marzougui
PhD, Faculty of Mathematical, Physical and Natural Sciences El Manar University - Tunisia

Karakaya Seniye
Physics Department, Eskisehir Osmangazi University, TURKEY

Boran Sorina
Assistant Professor, Faculty of Industrial Chemistry and Environmental Engineering, Department CAICON, University of Politehnica Timisoara, Romania

Isam A.H. Abdullah Al Zubaidi
Industrial System Engineering Program, Faculty of Applied Science and Engineering, University of Regina, Canada

Ivailo Milanov Pandiev
Associate Professor and Departmental Researcher, Technical University of Sofia, Faculty of Electronic Engineering and Technologies, Department of Electronics, Sofia, Bulgaria

Shiba Prasad Adhikari
Ph.D., Wake Forest University, Winston Salem, NC, USA

Simona Alina Ana POPA
Senior Lecturer Doctor Engineer, "Politehnica" University of Timișoara, Romania

Nusrat Sharmin
Assistant Professor, Department of Chemical and Environmental Engineering, Faculty of Science Engineering, University of Nottingham Ningbo China, China

Professor Dr. M.R. Sahar
Universiti Teknologi, Malaysia

Abdullah K. Al-Janabi
Department of Mechanical and Industrial Engineering, College of Engineering, Sultan Qaboos University, Al-Khoud, Sultanate of Oman

Ahmed Salih Mohammed
Lecture, Department of Civil Engineering, University of Sulaimani, Sulaimani, Kurdistan Region- Iraq

Ana Rita Colaço Morais
PhD, Department of Chemistry, Faculty of Science and Technology, Universidade NOVA de Lisboa, Portugal

Dr. M. V. Reddy
Dr., Departments of Physics, National University of Singapore (NUS), Singapore

Marcus Müller
Project Manager, Technical University of Munich, Munich, Germany

Rajendra Singh Meena
Ph.D, Quantum Phenomena and Application, National Physical Laboratory, India

Bertrand Tchanche Fankam

Tao Yang
TEMA, University of Aveiro, Portugal

Suvanjan Bhattacharyya
Assistant Professor, MCKV Institute of Engineering, Howrah, West Bengal, India

Fredy Ernesto Cañizares Niño
Branch of Sustainable Energy Supply, Brandenburg University of Technology, Germany

Wathiq Rafa Abed
Faculty of Science and Engineering, Plymouth University

Leonid A. Anisimov
Volgograd Research Institute of Petroleum Industry (LUKOIL-Engineering, Volgograd NIPImorneft, Volgograd

Manish Saxena
Business Development & Consultancy, Punjab Renewable Energy Systems Pvt. Ltd., India

Faith Aydogan
Center for Advanced Energy Studies (CAES), University Blvd., USA

Sherif A. Mohamed
Mechanical Engineering Department, Sohag University, Egypt

Delshad Panahi
Electrical & Computer Engineering, Curtin University, WA, Australia

Meziane Rachid
Professor, University of SidiBel Abbes, Algeria

Dr. Gokhan AHMET
Department of Aerospace Engineering, Middle East Technical University, Turkey

Hardev Singh Virk
Visiting Professor, SGGS World University, Pakistan

Hiroki Nara
Lecturer, Department of Applied Chemistry, Waseda University, Japan

Renata Włodarczyk
Ph. D., Department of Energy Engineering, Czestochowa University of Technology, Poland

Qingtao Zhou
Postdoctoral Research Associate, Department of Geosciences, Environmental Research Building, Boise State University, USA

Hengbing Zhao
Associate Project Scientist, Institute of Transportation Studies, University of California, United States

Hua Chen
Technical Director, National Laboratory of Engine Turbocharging Technology, North China Engine Research Institute, 96 Yongjin Road, Beichen District, Tianjin

Daniel Vasconcellos De Sousa Stilpen
PhD, Federal University of Rio de Janeiro, Rio de Janeiro, RJ, Brazil

Khalid Kamhawi
PhD, Petrofac, UK

Dr. Ping Lu
Senior Researcher, Hydrodynamics & Energy, Corporate Offshore Technology (R&D), American Bureau of Shipping, USA

Alakangas Eija Anneli
Principal Scientist, Technical Research Centre of Finland VTT Ltd, Finland

Javier Rubio-Garcia
Researcher, Imperial College London (UK)

Zhenjun Ma
Senior Lecture, Sustainable Buildings Research Centre (SBRC), University of Wollongong, Australia

Prof. Dr. Cem ŞENSÖĞÜT
Prof. Dr., Mining Engineering Department, Dumlupinar University, TURKEY

Haitao Ye
PhD, Reader in Nanotechnology Science, School of Engineering and Applied Science, Aston University, UK

Matthias KUBA
PhD in Chemical Engineering, Vienna University of Technology, Austria

Elaheh Najafi
PhD, Yazd University

Osama Tobail
Senior Research Scientist, Egypt Nanotechnology Center (EGNC), Egypt

Wael Mahmoud Badawy Gad
Egyptian Atomic Energy – Nuclear Research Center- Radiation Protection & Civil Defense Dept, Egypt

Sastry Pamidi
Associate Professor, Electrical and Computer Engineering, FAMU-FSU College of Engineering, Tallahassee, FL

Xiaotao Wang
Assistant researcher, The Technical Institute of Physics and Chemistry of the CAS, China

Yaguang Yang
Project Manager, U.S. Nuclear Regulatory Committee, Rockville, MD

Cristina Lopez

Grazia Leonzio
Ph.D., Chemical Engineering, L'Aquila University

Ahmad H. Bani Younes
Assistant Professor, Khalifa University, Abu Dhabi, UAE

Karima BEN HAMOU
Ph.D., Cadi Ayyad University, Faculty of Science and Technology, Marrakech, Morocco

Marco Bellini
PhD in "Chemical Sciences", Department of Chemistry "Ugo Schiff", University of Florence, Italy

Michela Longo
Assistant Professor, Department of Energy, Politecnico di Milano, Italy

Amjad Anvari-Moghaddam
PhD., Department of Energy Technology, Aalborg University, Aalborg, Denmark

Mohamed Saber Ahmed Ibrahim Sokar
Assistant professor, faculty of engineering at Shubra, mechanical engineering department, Benha University, Greater Cairo, Egypt

Arin Hovanesian
M.Sc., Islamic Azad University, Iran

Chetan Mutha
Ph.D., Mechanical Engineering, The Ohio State University, USA

Edris Madadian
PhD Candidate, Faculty of Engineering, Department of Bioresource Engineering, McGill University, Canada

Sathishkumar Gurupatham
Assistant Professor, Southern Polytechnic State University, Georgia, USA

S. Harish
Assistant Professor, International Institute of Carbon-Neutral Energy Research (WPI-I2CNER), Kyushu University, Fukuoka, Japan

Nicola Delmonte
Assistant Professor, Department of Information Engineering – University of Parma, Parma, Italy

Dr. Harikishan Reddy Ellamla
Postdoctoral Research Fellow, HySA Systems and Validation Centre, SAIAMC, UWC, South Africa

Sathishkumar Gurupatham
Assistant Professor, Southern Polytechnic State University, USA

S. Harish
Assistant Professor, International Institute of Carbon-Neutral Energy Research (WPI-I2CNER), Kyushu University, Japan

Dr. Harikishan Reddy Ellamla
Postdoctoral Research Fellow, HySA Systems and Validation Centre, South Africa

Nicola Delmonte
Assistant Professor, Department of Information Engineering, University of Parma, Italy

Slawomir Ciešlik
Professor, UTP University of Science and Technology, Poland

Hessam Keshtkar Vanashi
PhD., Electrical Engineering, West Virginia University (WVU), USA

Ozoemena Anthony Ani
Senior Lecturer and Coordinator, University of Nigeria, Nigeria

Jeffrey A. Hoffman
Associate Professor, Department of Mechanical Engineering, University of Alaska Anchorage, USA

Nikolaos Tzouganatos
Doctoral Researcher, Solar Technology Laboratory of the Paul Scherrer Institute (PSI), Switzerland

Adarsh Kumar Pandey
Senior Lecturer, University Malaya Power Energy Dedicated Advanced Centre (UMPEDAC), Malaysia

Frank Alberto Ibarra Hernández
PhD., São Paulo State University (UNESP), Brazil

George Adeyinka Oguntala
Lecturer, National Open University, Nigeria

Ha Lac Nguyen
Vietnam National University, Viet Nam

Vladimir I. Astafev
Professor of the Department of Oil and Gas Fields Development, Samara State Technical University, Russia

El-Sayed Abd El- Azim Youssef El- Agouz
Prof. Dr., Department of Mechanical Power Engineering, Faculty of Engineering, Tanta University, Egypt

Dr.-Ing. Prashanth Konda Gokuldoss
Erich Schmid Institute of Materials Science, Academy of Sciences, Austria

Annie Sim
AECOM Singapore Pte. Ltd., Singapore

Tarek Mohammad Aboul-Fotouh Mohammad
Lecturer, Mining and Petroleum Engineering Department, Faculty of Engineering, Al-Azhar University, Cairo, Egypt

Peter Holstein
SONOTEC Ultraschallsensorik Halle GmbH, Germany

Sina Askarinejad
Ph.D. Candidate, Worcester Polytechnic Institute, Worcester, Massachusetts USA

Adawiya Jumaa Haider
Prof. Dr., University of Technology, Baghdad, Iraq

Tsutomu DEI
Lecturer, Ashikaga Institute of Technology, Japan

Gerd Dobmann
Chair for NDT and Quality Assurance, Saar-University, LZFPQ, Germany

Omar Abdel-Rahim
Ph. D., Dept. of Electrical & Electronic Eng., Utsunomiya University, Japan

W.M.N.M.B. Wanninayake
Doctor, Nanoscience and Nanotechnology Postgraduate Institute of Science, University of Peradeniya, Sri Lanka

Abhik Sur
University College of Science and Technology, India

Kaouthar DeghdakBoukebab
Ph. D., François Rabelais University of Tours, France

Hesam Kamyab
Ph.D., University Technology Malaysia (UTM), Malaysia

Bugra Ocak
Ph.D., Associate Professor, Leather Engineering Department, Ege University in Izmir, Turkey

Pilar Lukas
Head, ÚJV Rež, a. s., ENERGOPROJEKT PRAHA Division, Czech Republic

Lidia Dobrescu
Professor, POLITEHNICA University of Bucharest, Romania

Vishal B. Pattanashetty
Assistant Professor, B.V.Bhoomaraddi College of Engineering and Technology, INDIA

Sahal Mustapha
Research Assistant Professor, Ibn Zohr University, Morocco

Sören Eikemeier
Research Executive Agency, European Commission, Germany

Cemal Basaran
Ph.D., University at Buffalo, USA

Selina AmaSaah
Ph.D., Department of Chemistry, Kwame Nkrumah University of Science and Technology (KNUST), Ghana

K. Nematollahi
Ph.D., Mechanical/Structural Engineering, Purdue University, USA

BARBU PAULA
Ph.D., University POLITEHNICA of Bucharest, Faculty of Applied Chemistry and Materials Science, Romanian

MIHAI IORDOC
Ph.D., University POLITEHNICA of Bucharest, Faculty of Applied Chemistry and Materials Science, ROMANIAN

Alicia Manjón Sanz
PhD., Postdoctoral Scholar, Oregon State University, US

Tawanda Mushiri
D.Eng. candidate, Doctoral for D. Eng., University of Johannesburg, South Africa

Mowffaq Orejiah
Ph.D., Assistance Professor, Umm Al-Qura University, Makkah, Saudi Arabia

Rajiv Kumar Pandey
Ph.D., IIT-BHU, Varanasi, India; Postdoctoral fellow, Energetic Research Institute, Nanyang technological University, Singapore

Yinkai Lei
Postdoctoral Researcher, National Energy Technology Laboratory, 1450 SW Queen Ave Albany, OR 97322

Sushila Shrestha
Ph.D. Scholar (Ecology and Environment), Central Department of Botany, Tribhuvan University, Nepal

Khug Alam
MPhil (Mathematics), Kohat University of Science & Technology (KUST)

Dongkyu Kim
Postdoc., Microfluidics group/Energy research, KIST-Europe, Saarbuecken, Germany

Arul varman K
Ph.D., Department of Materials Engineering, Indian Institute of Science, Bangalore-560012, India

Arsalan Haider
B.Sc, Lecturer of Electrical Engineering for Diploma in Associate Engineering (DAE), Pakistan

Rashid Miandad
Ph.D., King Abdulaziz University, Jeddah, Saudi Arabia

Dr.N.Rajesh Jesudoss Hynes
Associate Professor, Mepco Schlenk Engineering College, Sivakasi-626005, INDIA

Dubale Amare Aregahegn
Assistant professor, Dilla University, Dilla Ethiopia

Marco Coco
Ph.D. in Mathematics and Computer Sciences, University of Catania, Italy

José Manoel Antelo Gomez
Ph.D. in Energetic Planning, Brazil

R. RAJ MOHAN
Assistant Professor (OG), Department of Mechanical Engineering, TRP Engineering College (SRM Group) – Trichy

Oleksandr V. Bondarenko
Assistant Professor, Theory and Ship Design Department Admiral Makarov National University of Shipbuilding, Ukraine

Soumyadip Choudhury

Post-doctoral fellow at Energy Materials Group at the INM - Leibniz Institute for New Materials, Germany

Che-Chia Hu
Assistant Professor , Chung Yuan Christian University, Taiwan

Ernesto Elenter Grimberg
Director of the Department of Energy Efficiency at SEG Ingeniería

Maher Damak
PhD Candidate, Massachusetts Institute of Technology (MIT), Cambridge, MA

Muzammil Anjum
Ph.D., King Abdulaziz University, Jeddah, Saudi Arabia

Mazarakos Thomas
Post Doctoral Research Engineer, National Technical University of Athens, Greek

YOUNES EL KHCHINE
Ph.D., Teacher of solid Mechanics at Polydisciplinary Faculty of Taza, Morocco

Yrèbégnan Moussa SORO
Postdoctoral, Head of department of Electrical, Energy & Industrial Engineering at 2IE Foundation, Ivorian

SANAE EL OUAHDANI
Ph.D., temporary teacher, Faculty of Sciences Abdelmalek Essaâdi in Tetouan , Morocco

Gustavo de Melo Ribeiro
Master of Science on Energy at the Institute of Energy and Environment of the University of São Paulo, Brazil

KESHAV SHRESTHA
Postdoctoral Researcher, Idaho National Laboratory, Idaho Falls, ID

Xunyuán Yín
Ph.D., University of Alberta, Edmonton, Canada

John Njagi Nguu,
Ph.D., Department of Science and Engineering, Daystar University, Nairobi

Paper Status Tracking >>



- Journals by Title >>
- China-USA Business Review
 - Chinese Business Review
 - Communication and Public Dipl...
 - Computer Technology and Applic...
 - Cultural and Religious Studies
 - Economics World
 - History Research
 - International Relations and Di...
 - Journal of Aerospace Science a...
 - Journal of Agricultural Scienc...

- Journals by Subject >>
- Biomedical & Life Sciences
 - Business & Management
 - Chemistry & Materials Science
 - Computer & Communications
 - Earth & Environmental Science
 - Engineering
 - Humanities
 - Physics & Mathematics
 - Social Sciences

- Useful Links >>
- The old version website entrance
 - HeinOnline
 - ProQuest
 - LIBRARY of CONGRESS
 - EBSCO
 - Ulrich



>>

This work is licensed under a Creative Commons Attribution-NonCommercial 4.0 International License

Facebook :

Twitter :

LinkedIn :

Contact us

David Publishing Company, 3 Germay Dr., Unit 4 #4651, Wilmington DE 19804

Tel:1-323-984-7526; Fax:1-323-984-7374

Email: order@davidpublishing.com

www.davidpublisher.org

www.davidpublisher.com



From Knowledge to Wisdom

Journal of Energy and Power Engineering, USA

International Standard Serial Number: ISSN1934-8975, USA

Paper Acceptance Notice

April 05, 2016

Dear *Waluyo and Yan Maret Hutasoit*,

It is my pleasure to inform you that your paper entitled "Testing Performance of Low Voltage Arresters" has been accepted by the Journal of Energy and Power Engineering (ISSN1934-8975), and it has been published in June, 2016.

If you have any question, please don't hesitate to contact.

Thank you for your attention to the *Journal of Energy and Power Engineering*.

Sincerely

Editorial Department

Journal of Energy and Power Engineering

David Publishing Company

Address of Headquarters: 616 Corporate Way, Suite 2-4876, Valley Cottage, NY 10989, USA.

Tel: 1-323-984-7526, 323-410-1082; Fax: 1-323-984-7374; 323-908-0457

E-mail: energy@davidpublishing.org, energy@davidpublishing.com. Website: <http://www.davidpublisher.com>

Paper Status Tracking >>



Journals by Title >>

- China-USA Business Review
- Chinese Business Review
- Communication and Public Dipl...
- Computer Technology and Appli...
- Cultural and Religious Studies
- Economics World
- History Research
- International Relations and Di...
- Journal of Aerospace Science a...
- Journal of Agricultural Scienc...

Journals by Subject >>

- Biomedical & Life Sciences
- Business & Management
- Chemistry & Materials Science
- Computer & Communications
- Earth & Environmental Science
- Engineering
- Humanities
- Physics & Mathematics
- Social Sciences

Useful Links >>

- The old version website entrance
- HeinOnline
- ProQuest
- LIBRARY of CONGRESS
- EBSCO
- Ulrich



This work is licensed under a Creative Commons Attribution-NonCommercial 4.0 International License

- Facebook
- Twitter
- LinkedIn

Article

Open Access

Testing Performance of Low Voltage Arresters

Author(s)
Waluyo and Yan Maret Hutasoit

Full-Text PDF XML 1187 Views
DOI:10.17265/1934-8975/2016.06.006

Affiliation(s)
Department of Electrical Engineering, National Institute of Technology (Itenas) Bandung 40124, Indonesia

ABSTRACT
Due to important consideration of protection against lightning surge on electrical, electronic and telecommunication equipment, it was necessary to carry out a special study to look at the performance of protective devices. The study was testing performance of arresters on low voltage system. The activity was testing of arresters using steady state and impulse voltages. The arresters consisted of gas tube, zener diode, varistor and spark gap arresters, then it was made a cascade circuit between the varistor and spark gap arresters with a decoupling element. The decoupling elements were used air, iron and ferrite. The test yielded data of current and voltage on the tables and oscilloscope waveforms. The arresters had cut voltages early different from each other, namely the gas tube, zener diode, spark gap and varistor arresters were at the voltages of 500 V, 250 V, 1,000 V and 565 V respectively. The iron core decoupling element cascade circuit had the least oscillation among remaining cores.

KEYWORDS
Arrester, cascade, decoupling element, gas tube, impulse, varistor, zener diode.

Cite this paper

References

Testing Performance of Low Voltage Arresters

Waluyo and Yan Maret Hutasoit

Department of Electrical Engineering, National Institute of Technology (Itenas) Bandung 40124, Indonesia

Received: March 24, 2016 / Accepted: April 05, 2016 / Published: June 30, 2016.

Abstract: Due to important consideration of protection against lightning surge on electrical, electronic and telecommunication equipment, it was necessary to carry out a special study to look at the performance of protective devices. The study was testing performance of arresters on low voltage system. The activity was testing of arresters using steady state and impulse voltages. The arresters consisted of gas tube, zener diode, varistor and spark gap arresters, then it was made a cascade circuit between the varistor and spark gap arresters with a decoupling element. The decoupling elements were used air, iron and ferrite. The test yielded data of current and voltage on the tables and oscilloscope waveforms. The arresters had cut voltages early different from each other, namely the gas tube, zener diode, spark gap and varistor arresters were at the voltages of 500 V, 250 V, 1,000 V and 565 V respectively. The iron core decoupling element cascade circuit had the least oscillation among remaining cores.

Key words: Arrester, cascade, decoupling element, gas tube, impulse, varistor, zener diode.

1. Introduction

Franklin performed his initial experiments on electricity. Lightning is a natural phenomenon with destructive consequences. When a lightning falls on a structure, its current generates an impulse surge. It needs arresters for lightning protection [1-5].

Lightning electromagnetic impulse radiation must be taken into consideration because they endanger electrical and electronic systems. In the case when no arrester was damaged or was not yet damaged by current in the flash, about 40% of the return stroke peak current and about 25% or more of the return stroke charge transferred in the first millisecond [6-7].

It has been studied urban cloud-to-ground lightning. It was found an average enhancement of 60-100% on the lightning activity over three large metropolitan areas. The CG-lightning activity was enhanced within and downwind of most of the urban areas. It has indicated that a significant enhancement of approximately 100% in negative and 50% in positive flash densities. The observed ball lightning was

produced from electric fields caused by the accumulation of ions [8-12].

Installation of arrester assures reliable lightning protection [13]. Due to integration with existing systems of substations, the developed device allows for reception of information regarding arrester discharges [14]. Switching transients are caused by energization and de-energization of system components [15]. The energy overloading criterion of the SPD (surge protective device) was considered in LV (low voltage) network [16].

Overvoltages generated by lightning discharges to overhead lines can cause flashover [17]. Choosing nice technology and higher capacity electronic components can make withstand capability higher [18]. The arresters are designed for using in category C locations, include on transformer secondary [19]. The unpredictable threat of transient overvoltage is ever increased in low voltage power supplies [20].

Gas discharge tubes have evolved to provide reliable and effective protection solutions during lightning storms and other electrical disturbances. The magnitudes and waveforms of the lightning overvoltages depend on many line and stroke

Corresponding author: Waluyo, research fields: electrical power transmission line and high voltage engineering.

parameters [21, 22]. The installation of lightning arresters helps decrease the adversarial effects resulting of lightning strike in the feeder [23]. Moisture and partial discharges can be present simultaneously and contribute to the varistor degradation. It is important to identify hot lightning arrester with an IP (internet protocol) camera [24, 25].

Lightning arresters must be able to discharge high-energy lightning currents. Surge arresters only serve limiting over voltages at relatively low-energy surge currents. Testing of surge arresters is very important [26, 27]. Using multiple spark gap arresters, it is even possible to not create any follow current [28].

Gas-filled surge arresters operate on gas-physical principle of highly effective arc discharge and very low leakage current. Earthing and bonding shall always be provided, directly or via suitable SPD. The arrester provides a low-impedance path to ground for current from a lightning strike or transient voltage and then restores to a normal operating condition. ZnO material has superiority over SiC. The important factors of arrester are environmental factors, electrical shocks, time of installing and number of operations. Surge current has become the standard parameter for comparing suppression devices. A varistor is used to limit voltage at terminals. A zener diode is equipped with a special structure to optimize its limiting behavior on transient surges [29-35].

The parameters adjustment of simplified IEEE (Institute of Electrical and Electronics Engineers) model was achieved for an MOSA (metal oxide surge arrester). The impulse current generator needs to be improved in reducing its overall inductance for ZnO surge arresters [36, 37]. Assessing condition of MOSA indicated a comparable degree of degradation [38]. SPDs are spark gaps, gas discharge tubes and metal oxide varistors. Electrical stresses can be power frequency, temporary over voltages, and impulse stresses resulting from switching and lightning [39, 40].

SPDs are tested differently. It is of great importance to understand the characteristics and the intended use of devices. The application of SPDs can reduce the local over voltages to acceptable limits. Surge arresters are to ensure appropriate insulation coordination and to protect valuable equipment from lightning and switching over voltages [41-44].

It is shown that the lightning strokes and their effects are very dangerous to electronics devices. Thus, the arrester role is significantly important. Practically on sites, the low voltage arresters are used to protect electrical devices that installed on power outlets, BNC (bayonet neill-concelman) probes, and various electronic equipment, telecommunication and information networks. Therefore, it is necessary to investigate the performance of low voltage arresters. The objective of research was investigating the performance of low voltage arresters by using the tests. The arrester kinds were gas tubes, varistors, zener diodes, spark gap arresters. The tests were both steady state and impulse conditions.

2. Testing Methods

The hybrid generator showed the peak voltage and peak current impulses, and they were also indicated on the oscilloscopes. The test equipment and arrester components are shown in Fig. 1.

The specifications of hybrid generator were 1-10 kV of oc voltage (1.2/50 μ s), 3 kA (max) of sc current (8/20 μ s) and 2 Ω of impedance. The specifications of spark gap arrester were 350 V/50 Hz of rated voltage (U_c), 75 kA of impulse current, I_{imp} (10/350 μ s), \leq

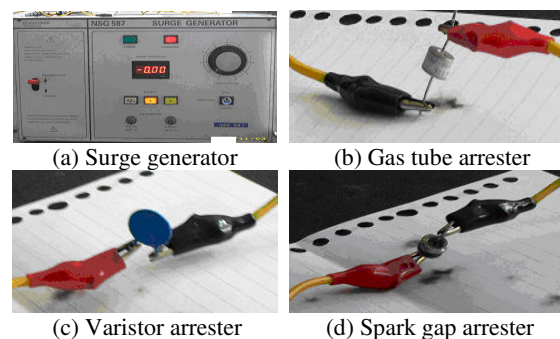

Fig. 1 Test equipment and arrester test objects.

1 kV of voltage protection level (1.2/50 μ s) and ≤ 100 ns of response time (t_A). The specifications of varistor were 100 V of U_c , 20 kA of nominal discharge current (I_{sn}), ≤ 1 kV at 5 kA (8/20 μ s) and ≤ 1.5 kV at I_{sn} of protection level voltage (U_p) and ≤ 25 ns of t_A . The specifications of gas tube arrester were 350 V/50 Hz of U_c , 70 kA of impulse current (10/350 μ s), I_{imp} , and ≤ 1 kV of U_p (1.2/50 μ s). The specifications of zener diode were 115 V of U_c and 10 kA of I_{sn} . In addition, the used decoupling element was 0.8 mm of wire diameter, whereas the cores were iron, ferrite and air, with 97 mm long and 8 mm diameter.

Fig. 2 shows the testing circuit of steady state conditions. Fig. 3a shows the impulse testing circuit on each arrester, and Fig. 3b shows the impulse testing circuit on cascade arresters.

The testing of gas tube arrester was in the way connected with the impulse generator with a positive impulse voltage (kV order) and the other end connected to the ground. The oscilloscope probe was connected to a series divider on the impulse generator. The tests were the same way for remaining arresters. The data of peak quantities were indicated on the generator panel. The voltage and current waveforms were shown on the oscilloscope.

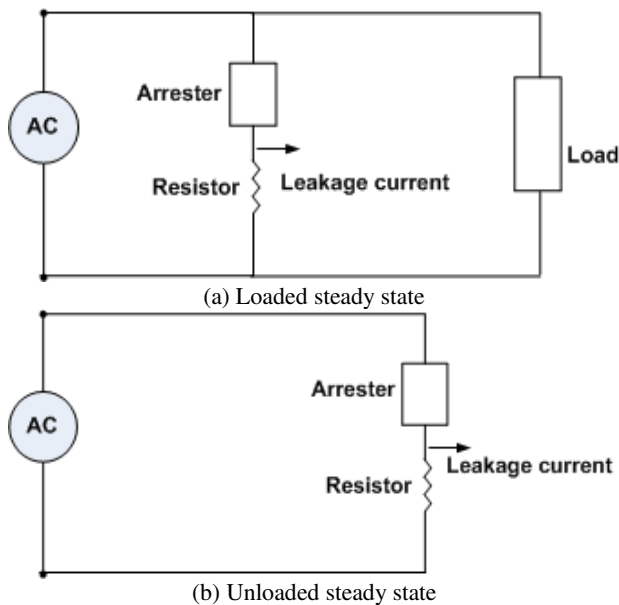

Fig. 2 Steady state testing circuits.

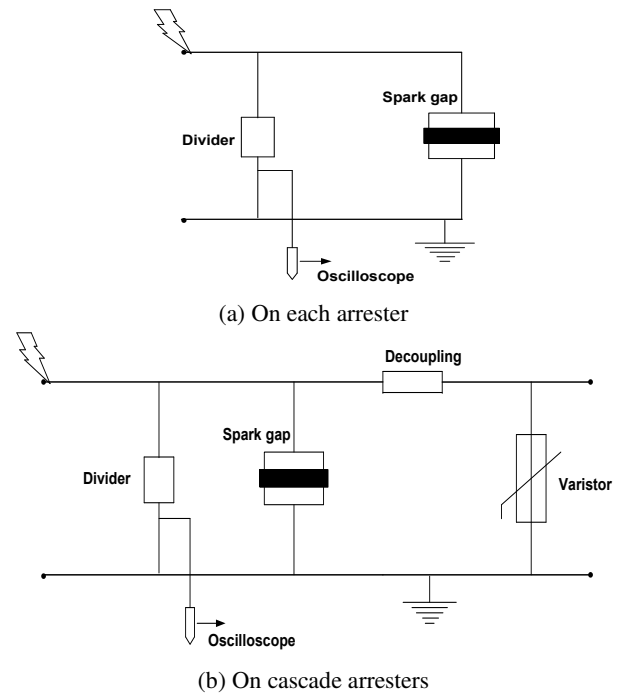

Fig. 3 Impulse testing circuits.

3. Test Results and Discussion

Table 1 lists the tests results of gas tube, zener diode, varistor and spark gap arresters, for steady state voltage without load, in range of 10 V to 200 V input voltages (V_i), peak-to-peak (V_{p-p}) and effective/rms voltages (V_{rms}).

Fig. 4 shows the curves of voltage values. The graph shows the slope tends to be constant, or does not get a change significantly. While, Table 2 lists the testing data of the arresters in steady state voltages with a load, in range of 10-200 V input voltages (V_i).

Table 1 No loading measurement result of arresters.

V_i (V)	Gas tube arrester (V)		Zener diode (V)		Varistor (V)		Spark gap arrester (V)	
	V_{p-p}	V_{rms}	V_{p-p}	V_{rms}	V_{p-p}	V_{rms}	V_{p-p}	V_{rms}
10	30	10.2	28	10	30	10.3	30	10.1
20	62	20.8	60	20.3	60	20.9	64	20.5
50	142	52.2	140	52.1	144	52.2	142	52.4
75	206	78.02	206	76.3	210	77.0	206	78.02
100	278	100	274	102	278	102	278	98.8
125	340	125	340	125	344	126	342	124
150	412	152	410	150	414	152	412	150
175	480	177	480	177	480	177	482	177
200	504	200	504	200	508	200	502	200

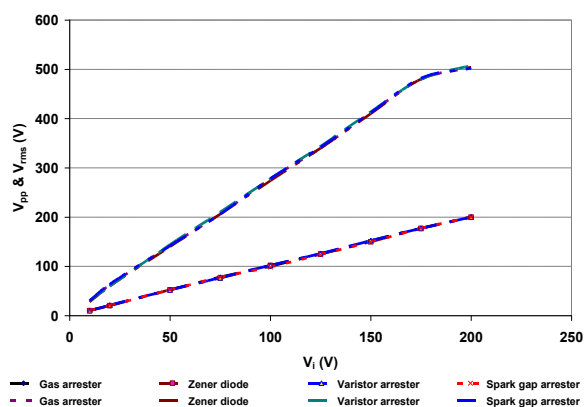

Fig. 4 Unloaded curves V_{pp} & V_{rms} - V_i testings.

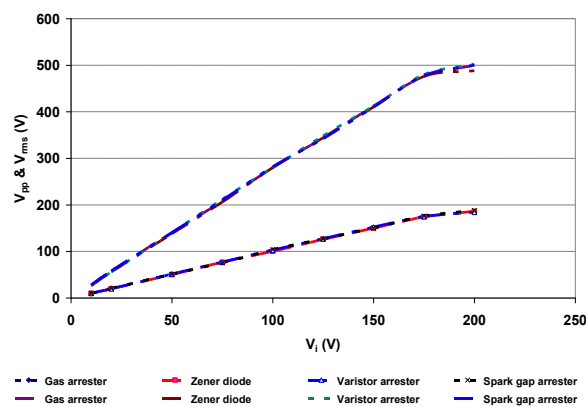

Fig. 5 Loaded curves of V_{pp} & V_i - V_p testings.

Table 2 Loaded measurement result of arresters.

V_i (V)	Gas tube arrester (V)		Zener diode (V)		Varistor (V)		Spark gap arrester (V)	
	V_{p-p}	V_{rms}	V_{p-p}	V_{rms}	V_{p-p}	V_{rms}	V_{p-p}	V_{rms}
10	28	9.4	26	10	28	10.2	28	9.5
20	58	20.7	56	19.6	56	19.8	58	20.6
50	140	51	138	50	140	51.2	140	51
75	208	75.8	206	76.5	212	76.9	210	75.6
100	280	102	280	100	280	103	282	104
125	344	126	344	126	348	127	342	127
150	412	151	410	150	412	152	410	150
175	476	175	476	174	480	175	478	176
200	500	184	488	186	502	184	500	188

From the curves in Fig. 5, the characteristics of the arrester were not much different from one another under normal circumstances either load or no-load. All arresters did not really give effect to the system, not interfere with voltage or current energy of supply. The leakage current or operating current of arresters was not visible from measurements using a multimeter or oscilloscope, and was not detected any voltage surge. On the high values of input voltages, the peak-to-peak voltages would be saturated. These cases were caused by the voltage drop due to the loading of circuits.

The testings of gas tube arrester with the impulses were done by subjecting range impulse voltage of 0.5-6 kV. The data were detected and recorded when the testing of gas tube arresters began to penetrate up to 6 kV of impulse voltage. The data are listed in Table 3.

The Table 3 lists impulse voltages (V_i), cut voltages (V_c) and cut currents (I_c), started the impulse voltage

Table 3 Measurement data of gas tube arrester.

V_i (V)	V_c (V)	I_c (A)
500	88	100
1,000	160	500
2,000	304	900
3,000	456	1,200
4,000	620	1,400
5,000	900	1,900
6,000	1,140	2,200

of 500 V with the cut voltage of 88 V and the cut current of 100 A. While, the samples of test waveforms are shown in Figs. 6 and 7.

Fig. 8 shows the V_c - V_i and I_c - V_i curves of the gas tube arrester. The cut voltage and current waveforms were almost constant. The voltage waveform was looked not directly towards zero, but there was little residue due to an arc voltage. The voltage and current waveforms show toward zero and go beyond the negative area. This case was caused the energy released by inductive components either in the arrester or generator circuit, where the currents were stored in the form of magnetic energy. The arrester absorbed energy would release in the form of thermal energy arc. Based on the figures, the measured cut impulse voltage and current waves were proportional to the input impulse voltages.

The testings of zener diode were done by applying the impulse voltages, from few hundreds of volts up to 1 kV, since above 1 kV, it would start to damage. This case was normal and it was quite dangerous to continue test above 1 kV. Table 4 lists the impulse voltage for

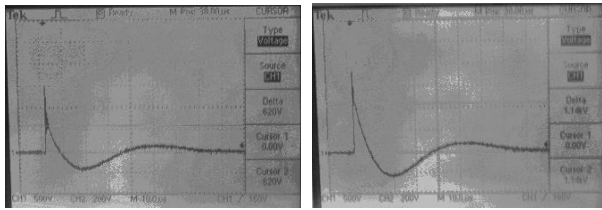

(a) $V_i = 4$ kV

(b) $V_i = 6$ kV

Fig. 6 Cut voltage waveforms of gas tube arrester.

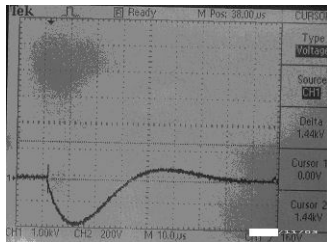

Fig. 7 Cut current waveform of gas tube arrester.

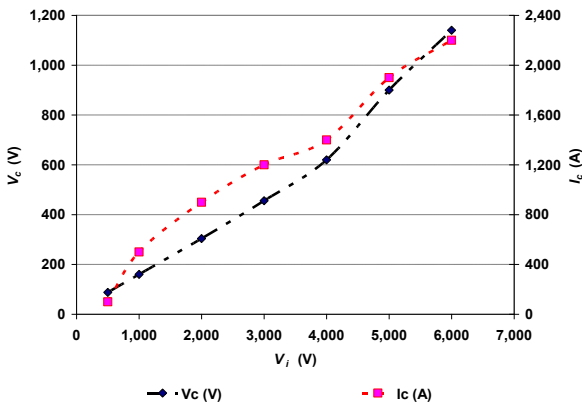

Fig. 8 Curves of V_c - V_i and I_c - V_i of gas tube arrester.

Table 4 Test data of the zener diode.

V_i (V)	V_c (V)	I_c (A)
250	72	50
500	96	85
1,000	160	180

cut voltages and cut currents on the zener diode.

Fig. 9 shows the test data of cut voltage waveforms at impulse voltage (a) 250 V, (b) 500 V and (c) 1 kV, on the zener diode.

Fig. 10 shows a sample of cut current waveform of test result on the zener diode.

Fig. 11 shows the cut voltage and current curves versus the impulse voltage on the zener diode. Generally, the cut voltages and currents would rise as the impulse voltages increased.

The cut voltage and cut current waveforms were not

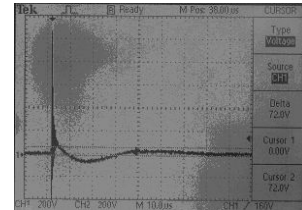

(a) $V_i = 250$ V

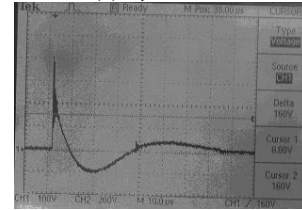

(b) $V_i = 500$ V

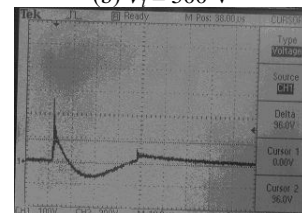

(c) $V_i = 1$ kV

Fig. 9 Cut voltage waveforms of zener diode test results.

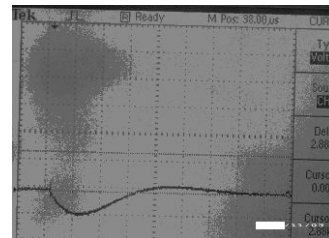

Fig. 10 Cut current waveform of zener diode test result.

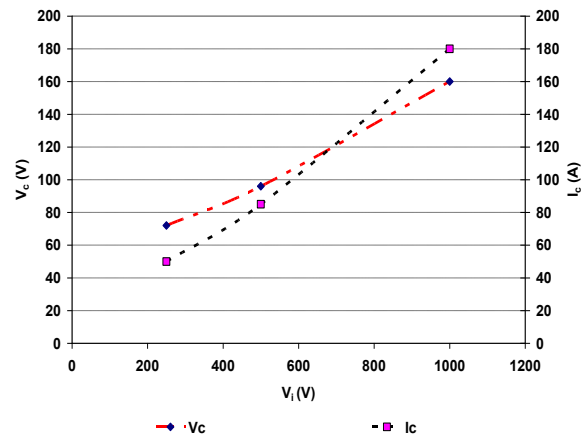

Fig. 11 Curves of V_c - V_i and I_c - V_i for zener diode.

constant and looked more serrature or dense oscillation. This should be reduced by reducing installation cable. The voltage waveforms could also be seen indirectly toward zero. Nevertheless, there was little residue due

to an arc voltage.

The spark gap arrester testing was performed by applying the impulse voltages in ranging of 1-6 kV. The recorded data were the testing data when the spark gap arrester began to breakdown. The obtained data are listed in Table 5. The table lists the values of impulse voltage, cut voltage and cut current.

The samples of cut voltage and cut current waveforms are shown in Figs. 12 and 13.

It could be made the cut voltage and the cut current curves versus the impulse voltage of the spark gap arrester. These curves are shown in Fig. 14.

The cut voltage and cut current trends were nearly similar. The voltage waveforms were looked directly

Table 5 Test result data of the spark gap arrester.

V_i (V)	V_c (V)	I_c (A)
1,000	920	0
2,000	1,800	900
3,000	2,320	1,200
4,000	2,560	2,100
5,000	2,930	2,600
6,000	3,120	2,900

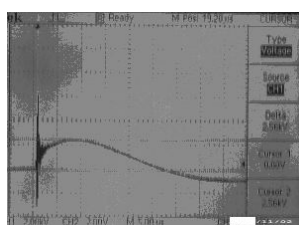

(a) $V_i = 4$ kV

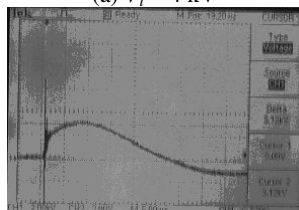

(b) $V_i = 6$ kV

Fig. 12 Cut voltage waveforms of spark gap arrester.

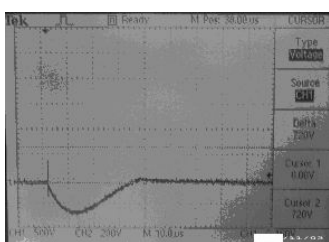

Fig. 13 Cut current waveform of spark gap arrester.

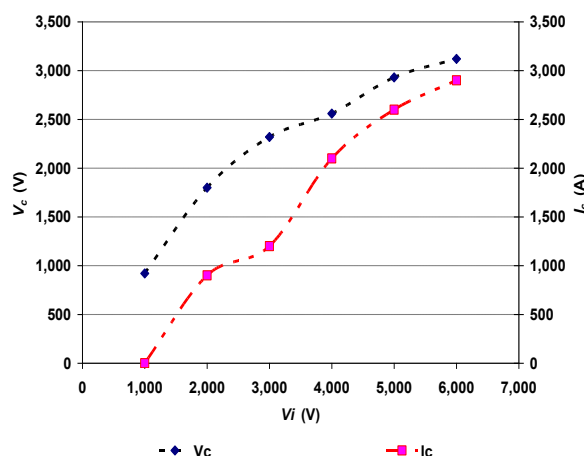

Fig. 14 Curves of V_c-V_i and I_c-V_i of spark gap arrester.

towards zero, but there was little residue in the form of an arc voltage. Some testings showed the voltage and current went beyond to zero and entered to the negative area. This was due to the energy released by an inductive component either in the arrester or generator circuits, after these components stored magnetic energy. The energy was absorbed by the arrester and released in thermal energy arc form.

The varistor arrester testings began in range 565 V-6 kV. Table 6 lists the correlation data between the impulse voltage and the cut voltages and the cut currents of the varistor.

The samples of cut voltage and cut current waveforms of varistor arrester test results are shown in Fig. 15.

Fig. 16 shows a sample of the cut current waveform of the varistor arrester for the impulse voltage of 4 kV.

Fig. 17 shows the curves of cut voltage and cut current versus the impulse voltages for the varistor. The specific behavior of the varistor arrester was seen

Table 6 The varistor arrester testing results.

V_i (V)	V_c (V)	I_c (A)
565	252	20
1,000	348	199
2,000	440	720
3,000	656	1,270
4,000	848	1,790
5,000	1,040	2,340
6,000	1,340	2,900

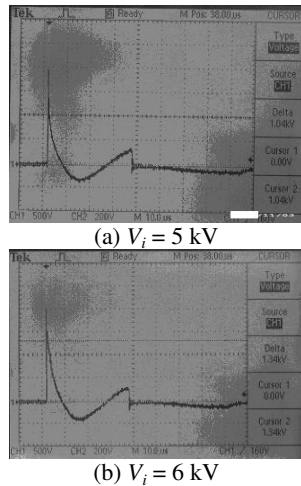

Fig. 15 Cut voltage waveforms of varistor arrester testings.

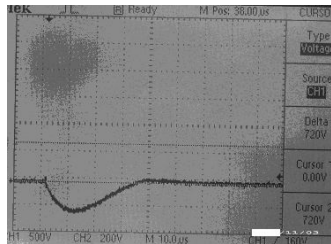

Fig. 16 Cut current waveform of varistor arrester.

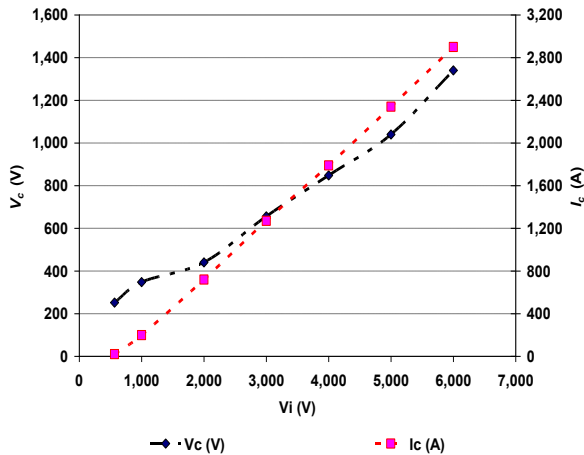

Fig. 17 Curves of V_c-V_i and I_c-V_i for the varistor.

its voltage clamping, before voltage drops to zero, and an undershoot voltage surge occurs. This was caused

by the inductance arrester parameters, testing circuit or generator inductance which releases the current after the cut voltage toward zero.

The testings with the decoupling coils were to get voltage drops and time delay, used the elements of iron, air and ferrite cores, which yielded data as listed in Table 7 [45].

The decoupling coils are shown in Fig. 18.

The impedance of the ferrite core decoupling element had the highest value among remaining cores. This case caused a voltage drop as the product of impedance and the current passing through element. It could create the spark gap arrester work faster than the remaining cores. The impedance of iron core decoupling element was different from the air core one due to the hysteresis and eddy current losses was taking part to the change. It was useful for determining the voltage drop of decoupling element in the design of arrester protection cascade coordination. A concern thing was an element impedance change existence as function of current, so that the determination of R , L , and C were not enough to determine the impedances.

The test results of cascade arresters were in the forms of cut voltages. The ferrite core decoupling element was the fastest to arrester work. It could be proved by the test cascade, that the arrester spark gap was always faster to work using ferrite core decoupling element, due to the higher voltage drop was summed the cut voltage of the varistor. Fig. 19 shows the cascade arrester voltage and current waveforms on the air core decoupling element.

Fig. 20 shows the cascade arrester voltage and current waveforms on the iron core decoupling element.

Table 7 The decoupling element parameter values.

Turns	Ferrite core				Air core				Iron core			
	R (Ω)	L (μ H)	C (μ F)	Z (Ω)	R (Ω)	L (μ H)	C (μ F)	Z (Ω)	R (Ω)	L (μ H)	C (μ F)	Z (Ω)
42	0.043	133.6	8.0	0.601	0.02	2.2	27.99	0.0343	0.054	14.7	38.60	0.211
82	0.076	273	4.6	4.354	0.046	27.6	8.83	0.363	0.416	129	11.45	2.174

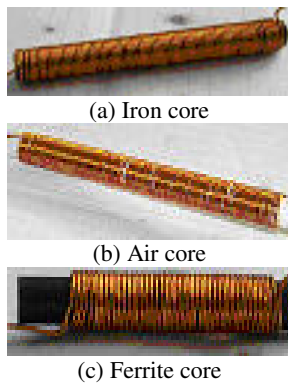

(a) Iron core

(b) Air core

(c) Ferrite core

Fig. 18 The iron, air and ferrite decoupling coil cores.

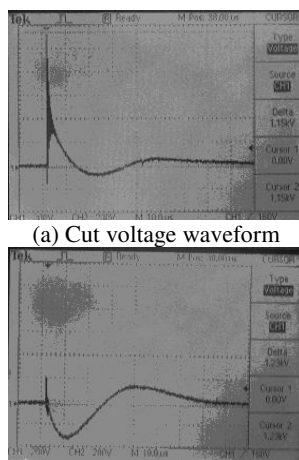

(a) Cut voltage waveform

(b) Cut current waveform

Fig. 19 Cascade arrester waveforms of air core element.

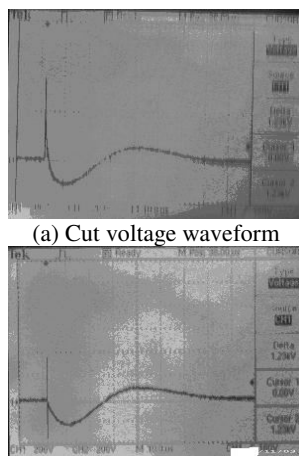

(a) Cut voltage waveform

(b) Cut current waveform

Fig. 20 Cascade arrester waveforms of iron core element.

Fig. 21 shows the cascade arrester voltage and current waveforms on the ferrite core decoupling element.

The value of initial breakdown voltage of the spark gap changed due to the cascade circuit existence. To create a spark gap arrester breakdown, it was required

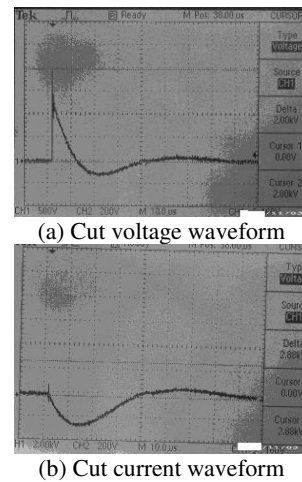

(a) Cut voltage waveform

(b) Cut current waveform

Fig. 21 Cascade arrester waveforms of ferrite core element.

a higher voltage. This case was caused by change in the voltage waveform became a cut voltage waveform because of the varistor. The voltages subjected to the spark gap were decoupling element voltage drops summed to the varistor cut voltages.

Before the spark gap arresters worked, the entire current passed through the varistor and decoupling elements. This current was a reference of varistor work planning. After it worked, the varistor was traversed by the current of 0.32 up to 10% only. Thus, it was to be noted how much capacity of the spark gap arrester was required, depending on the current through the system planning of lightning protection. While, the cut voltage of varistor arrester in the cascade circuit, tends to be relatively constant.

For choice of decoupling element core, it could be determined through a arrester cascade cut voltage, with various core kinds. By the change of impulse voltage sharpness, it would show the cut voltage with a high enough frequency on the air core decoupling element, that was about 400 kHz, it was about 100 kHz on the ferrite core decoupling element, and it did not arise an oscillation on the iron core decoupling element. If the system protected working with frequency range several hundred kilohertz, the iron core decoupling element was the best choice.

It was found an undershoot voltage waveform in the varistor. This case could be a serious problem if it

increased and reached a value equal to the input impulse voltage. Therefore, it was necessary to increase the decoupling element impedance up to the element drop voltages which were high enough to make the spark gap arrester work.

4. Conclusions

It could be seen that the steady state output voltages tend to be linear. The arresters did not disturb the system line voltages. Otherwise, based on the impulse tests the varistor and gas tube arresters had almost the same initial cut voltages, whereas the highest cut voltage was occurred on the spark gap, as around 1 kV. For the oscillation wave phenomena, the gas tube and varistor arresters had at least oscillation compared to the zener diode and spark gap arresters.

The change of decoupling element cores in the arrester cascade would make the resistance, inductance and capacitance changed significantly. The decoupling element impedance of the ferrite core was the highest, followed by the iron and air cores ones respectively. Thus, the coordination of arrester cascade decoupling element with the ferrite core would work fastest compared to the remaining cores in the same impulse value.

Acknowledgments

Authors here with respect offer thanks to High Voltage and High Current Laboratory STEI-ITB and National Institute of Technology (Itenas) Bandung for supporting the research project and publication.

References

- [1] Cooray, V. 2010. *Lightning Protection, The Institution of Engineering and Technology*. IET Power and Energy Series 58.
- [2] Seraudie, C. 1999. LV Surges and Surge Arresters, LV Insulation Co-ordination, Cahier Technique No. 179, Schneider Electric.
- [3] Cohen, R. L. 2005. *How to Protect Your House and Its Contents From Lightning: Surge Protection, IEEE Guide for Surge Protection of Equipment Connected to AC Power and Communication Circuits*. Standards Information Network, IEEE Press.
- [4] Pryor, L. 2016. "The Application and Selection of Lightning Arresters." Accessed March 6, 2016. apps.geindustrial.com.
- [5] Ali, S. A. 2013. "Design of Lightning Arresters for Electrical Power Systems Protection." *Power Engineering and Electrical Engineering* 11 (6): 433-42.
- [6] Dehn. 2012. *Lightning Protection Guide*, Revised 2nd edition, Germany: 14-6.
- [7] Mata, C. T., Rakov, V. A., Rambo, K. J., Diaz, P., Rey, R., and Uman, M. A. 2003. "Measurement of the Division of Lightning Return Stroke Current among the Multiple Arresters and Grounds of a Power Distribution Line." *IEEE Transactions on Power Delivery* 18 (4): 1203-8.
- [8] Stallinsa, J. A., and Bentley, M. L. 2006. "Urban Lightning Climatology and GIS: An Analytical Framework from the Case Study of Atlanta." *Applied Geography* 26 (3-4): 242-59.
- [9] Naccarato, K. P., Pinto, J. O., and Pinto, I. R. C. A. 2003. "Evidence of Thermal and Aerosol Effects on the Cloud-to-Ground Lightning Density and Polarity over Large Urban Areas of Southeastern Brazil." *Geophysical Research Letters* 30 (13): 71-4. doi:10.1029/2003GL017496.
- [10] Soriano, L. R., and Pablo, F. 2002. "Effect of Small Urban Areas in Central Spain on the Enhancement of Cloud-to-Ground Lightning Activity." *Atmospheric Environment* 36 (17): 2809-16.
- [11] Pinto, I. R. C. A., Pinto, J. O., Gomes, M. A. S. S., and Ferreira, N. J. 2004. "Urban Effect on the Characteristics of Cloud-to-Ground Lightning over Belo Horizonte-Brazil." *Annales Geophysicae* 22 (January): 697-700.
- [12] Lowke, J. J., Smith, D., Nelson, K. E., Crompton, R. W., and Murphy, A. B. 2012. "Birth of Ball Lightning." *Journal of Geophysical Research* 117 (October): 1-7.
- [13] Podporokin, G. V., Pilshikov, V. E., and Sivaev, A. D. 2016. "Application of Long Flashover Arresters for Improvement of Lightning Protection and Operating Voltage Reliability of Distribution Lines." Appalachian State University. Accessed March 6, 2016. <http://www.appstate.edu/~clementsjs/surfaceflashover/lightningflashover.pdf>.
- [14] Vladimir, G. 2007. "High Current Pulse Transducer for Metal-Oxide Surge Arresters." *UDC* (2): 22-4.
- [15] Chiesa, N. 2010. "Power Transformer Modeling for Inrush Current Calculation." Ph.D. thesis, Norwegian University of Science and Technology.
- [16] Milardic, V., Uglesic I., and Pavic, I. 2008. "Selection of Surge Protective Devices for Low-Voltage Systems Connected to Overhead Line." *IEEE Transactions on Power Delivery* 25 (3): 1530-7.
- [17] Dau, S. K. O. 2008. "Modelling of Lightning Overvoltages for the Protection of Transmission Lines by

- Means of Shielding Wires and Surge Arresters.” Ph.D. Thesis, AGH University of Science and Technology.
- [18] Chai, Y. J., Zhou, W. J., He, R. D., and Zhao, L. X. 2007. “Experimental Study on Lightning Characteristics of Electronic Equipment’s Power Supply.” In *Proceedings of the World Congress on Engineering*, 1-4.
- [19] Eaton. 2015. Storm Trapper High Energy Low-Voltage Distribution-Class MOV Surge Arrester, Surge Arresters Catalog Data CA235015EN (April).
- [20] Paul, D. 2001. “Low Voltage Power System Surge Overvoltage Protection.” *IEEE Transactions on Industry Applications* 37 (1): 223-9.
- [21] Ardley, T. 2008. *First Principles of a Gas Discharge Tube (GDT) Primary Protector*. Bourns, Inc.
- [22] Piantini, A. 2008. “Lightning Protection of Overhead Power Distribution Lines.” Presented at the 29th International Conference on Lightning Protection, Uppsala, Sweden.
- [23] Sanabria, D. R., and Robles, C. R. 2003. “Lightning and Lightning Arrester Simulation in Electrical Power Distribution Systems.” University of Puerto Rico Mayagüez. Accessed March 6, 2016. http://ece.uprm.edu/~lorama/Proy_Rayos03.pdf.
- [24] Chrzan, K. L. 2004. “Influence of Moisture and Partial Discharges on the Degradation of High-Voltage Surge Arresters.” *European Transactions on Electrical Power* 14 (3): 175-84.
- [25] Strmika, R. 2003. “Lightning Arresters’ effect on Power Line Reliability.” In *Proceedings of the 2003 InfraMation Conference*, 1-5.
- [26] Hasse, P. 2000. *Overvoltage Protection of Low Overvoltage Systems*. 2nd edition, London: The Institution of Engineering and Technology.
- [27] Woodworth, J. 2008. *Guide For Selecting an Arrester Field Test Method*. ArresterWorks.
- [28] Meppelink, J., Drilling, C., Droidner, M., Jordan, E. G., and Trinkwald, J. 2016. “Lightning Arresters with Spark Gaps, Requirements and Future Trends of Development and Applications.” Accessed March 6, 2016. <http://obo.at/downloads/FUNKENS2.PDF>.
- [29] EPCOS. 2015. *Surge Arresters and Switching Spark Gaps*. Munich: EPCOS Product Profile.
- [30] Bouquegneau, C. 2006. “The Lightning Protection International Standard.” In *Proceedings of the 28th International Conference on Lightning Protection*, 1-6.
- [31] Hill, K. 2004. *Surge Arresters and Testing*. Double Engineering Company, 1.
- [32] Thipprasert, W., and Sritakaew, P. 2014. “Leakage Currents of Zinc Oxide Surge Arresters in 22 kV Distribution System Using Thermal Image Camera.” *Journal of Power and Energy Engineering* 2 (4): 712-7.
- [33] Hosseini, S. A., Razavi, F., Karami, M., Ghadimi A. A., and Madahi, S. S. K. 2012. “A New Method to Recognize the Status of SiC Surge Arresters in Substations.” *Indian Journal of Science and Technology* 5 (5): 2692-700.
- [34] Eaton. 2009. *Eaton’s Guide to Surge Suppression—Applications Notes*. Eaton Corporation Eaton’s guide to surge suppression.
- [35] FLPA (French Lightning Protection Association). 2000. *Precautions to be Considered for Use of Surge Arresters Tested According to Class 1 of IEC 61643-1*. French Lightning Protection Association.
- [36] Díaz, R., Fernández, F., and Silva, J. 2001. “Simulation and Tests on Surge Arresters in High-Voltage Laboratory.” Universidad Nacional de Tucumán. Accessed March 6, 2016. <http://www.herrera.unt.edu.ar/alta-tension/lat/publicaciones/paper2vf.pdf>.
- [37] Darus, A. B., Malek, Z. A., Afendi, M., and Piah, M. 2004. “New Design of High Voltage Surge Arresters.” Universiti Teknologi Malaysia. Accessed March 6, 2016. http://www.energy.siemens.com/hq/pool/hq/power-transmission/high-voltage-products/surge-arresters-and-limiters/Catalogue_HV_surge_arresters_en.pdf.
- [38] Mardira, K. P., and Saha, T. K. 2002. “Modern Electrical Diagnostics for Metal Oxide Surge Arresters.” *Transmission and Distribution Conference and Exhibition 2* (October): 672-6.
- [39] Michalopoulos, A. 2011. *Consideration of Surge Arresters for Low Voltage Mains Applications*. Master of Science in Engineering, Johannesburg.
- [40] WG A3.17, 2016. *Evaluation of Stresses of Surge Arresters and Appropriate Test Procedures, International Council on Large Electric Systems*. Working Group A3.17, Cigre. <http://www.cigre.org>.
- [41] W.G.C4.408. 2013. *Lightning Protection of Low-Voltage Networks*. Paris: Cigre.
- [42] Kanashiro, A. G., Zanotti, J. M., Obase, P. F., and Wilson, R. B. 2009. “Diagnostic of Silicon Carbide Surge Arresters of Substation.” *Wseas Transactions on Systems* 8 (12): 1284-93.
- [43] Richer, B., Schmidt W., Kannus, K., Lahti, K., Hinrichsen, V., Neumann, C., Petrusch W., and Steinfeld, K. 2004. “Long Term Performance of Polymer Housed MO Surge Arresters.” *CIGRÉ A3-110*: 1-8.
- [44] Asaadi, J., Conrad, J. M., Gollapinni, S., Jones, B. J. P., Jostlein, H., John, J. M. S., Strauss, T. S., Wolbers, S., and Zennamo, J. 2014. “Testing of High Voltage Surge Protection Devices for Use in Liquid Argon TPC Detectors.” *Journal of Instrumentation* 9 (September): 1-22.
- [45] Waluyo, and Hutasoit, Y. M. 2011. “The Influences of Decoupling Elements on the Testing of Low Voltage Spark Gap and Varistor.” In *Proceedings of the 46th International Universities Power Engineering Conference*, 1-5.



Journal of Energy and Power Engineering

Volume 10, Number 6, June 2016

David Publishing Company

616 Corporate Way, Suite 2-4876, Valley Cottage, NY 10989, USA

Tel: 1-323-984-7526, 323-410-1082; Fax: 1-323-984-7374, 323-908-0457

<http://www.davidpublisher.com>, www.davidpublisher.org

energy@davidpublishing.com, energy@davidpublishing.org, energy-power@hotmail.com

